

LAPIS



WALL TILE



GRANITI VICENTIA
GROUP

LAPIS

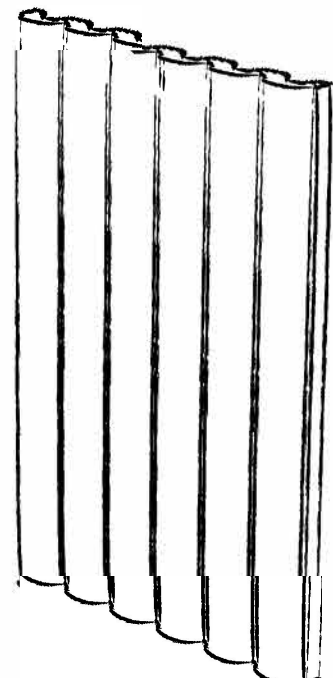

LAPIS

In occasione del 50° anno di attività, Ceramica , ha voluto celebrare la materia ceramica creando un originale prodotto d'interior design. LAPIS è una collezione di piastrelle da rivestimento in terracotta smaltata, fortemente caratterizzante lo spazio nel quale è inserita. La sua sezione formata da 6 semicerchi conferisce alla particolare superficie cannettata un aspetto tridimensionale e crea delle vibrazioni di luce e ombra in tutto l'ambiente circostante. LAPIS, in 27 diversi colori e superfici, misura 20x30x2 cm - 8"x12"x0,8", non ha bisogno di essere fugato, non ha bisogno di essere spiegato... Immagina semplicemente di rivestire la tua parete con tante matite colorate.

On the occasion of its 50th anniversary, Ceramica wanted to celebrate the ceramic material by creating an original product for interior design.

LAPIS is a glazed terracotta wall tiles collection, strongly characterizing the space in which is in. Its section formed by 6 semicircles gives the particular ribbed surface a three-dimensional appearance and creates light and shadow vibrations throughout the whole surrounding space.

LAPIS, available in 27 different colours and surfaces, is sized 20x30x2 cm - 8"x12"x0,8" it doesn't need to be grouted nor explained... Just imagine covering your wall with lots of coloured pencils!



LAPIS PALETTE DI COLORI
COLOURS PALETTE

Vedi la lista completa degli articoli da pag. 33 a pag. 43
See the complete item list from page 33 to page 43



COTTO CERATO
opaco



WHITE MOON
silk



WHITE MOON
craquelé



BIANCO MAIOLICA
craquelé



NUVOLA INTENSO
craquelé



TORTORA
craquelé



CIOCCOLATO
craquelé



NERO
laccato



GRAFITE
silk



DENIM
silk



VERDE OLIVA
craquelé



GIALLO SENAPE
craquelé



OASI INTENSO
craquelé



ROSSO CORALLO
craquelé



RENA INTENSO
craquelé



ROSA
craquelé



RENA LIMPIDO
craquelé



AMTHYST
craquelé



BLEU NOTTE
craquelé



RIO VELATO
craquelé



ABISSO VELATO
craquelé



LAGO VELATO
craquelé



OCEANO VELATO
craquelé



LAGO INTENSO
craquelé



LAGO LIMPIDO
craquelé



ARGENTO SIDERALE
metallo



BRUNO DORATO
metallo



NERO LUSTRATO
metallo madreperla



COTTO NATURALE



COTTO CERATO



SILK



LACCATO



BIANCO MAIOLICA



CRAQUÉ



ARGENTO SIDERALE



BRUNO DORATO

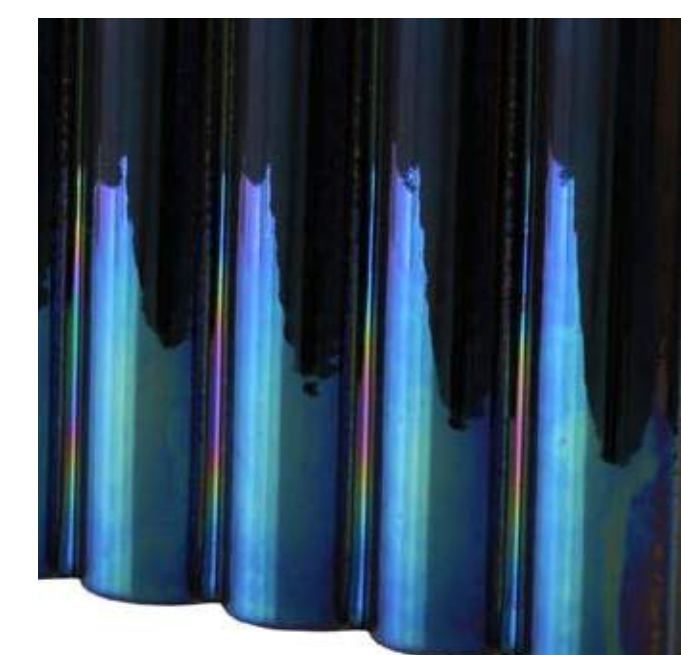

NERO LUSTRATO MADREPERLA



LP03

Rivestimento / Wall: Lapis White Moon craquelé 20x30x2 cm - 8"x12"x0,8" - LP167 Giallo Senape craquelé modulo 1 3,3x30x2 cm - 1,3"x12"x0,8" - LP427 Verde Oliva craquelé modulo 1 3,3x30x2 cm - 1,3"x12"x0,8" for Porto Pojana project - Project by Architect GPT Associati - Switzerland



LP01 Rivestimento / Wall: Lapis Special colours 20x30x2 cm - 8"x12"x0,8" - modulo 1 3,3x30x2 cm - 1,3"x12"x0,8" for Porto Pojana project - Project by Architect GPT Associati - Switzerland

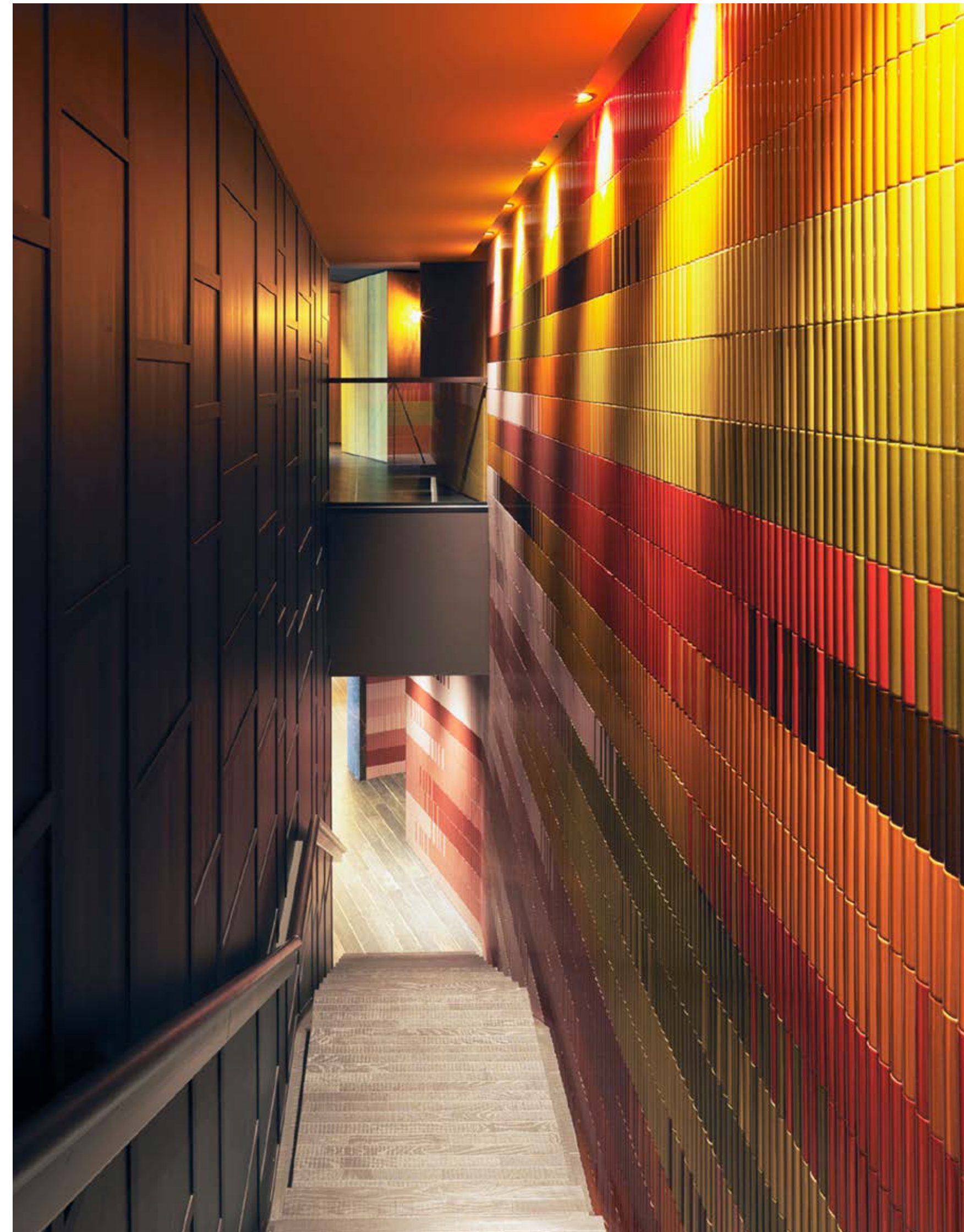

LP21 Rivestimento / Wall: Lapis Special colours 20x30x2 cm - 8"x12"x0,8"- modulo 1 3,3x30x2 cm - 1,3"x12"x0,8" for Porto Pojana project - Project by Architect GPT Associati - Switzerland



LP06 Rivestimento / Wall: Lapis Special colours 20x30x2 cm - 8"x12"x0,8" - modulo 1 3,3x30x2 cm - 1,3"x12"x0,8" and special size for Porto Pojana project - Project by Architect GPT Associati - Switzerland



LP48 Rivestimento / Wall: Lapis LP340 Rosa 20x30x2 cm - 8"x12"x0,8" for "Radical Sorrento" Brunch & Tapas Cafè - Project by Studio Sorrentino - Sorrento, Italy

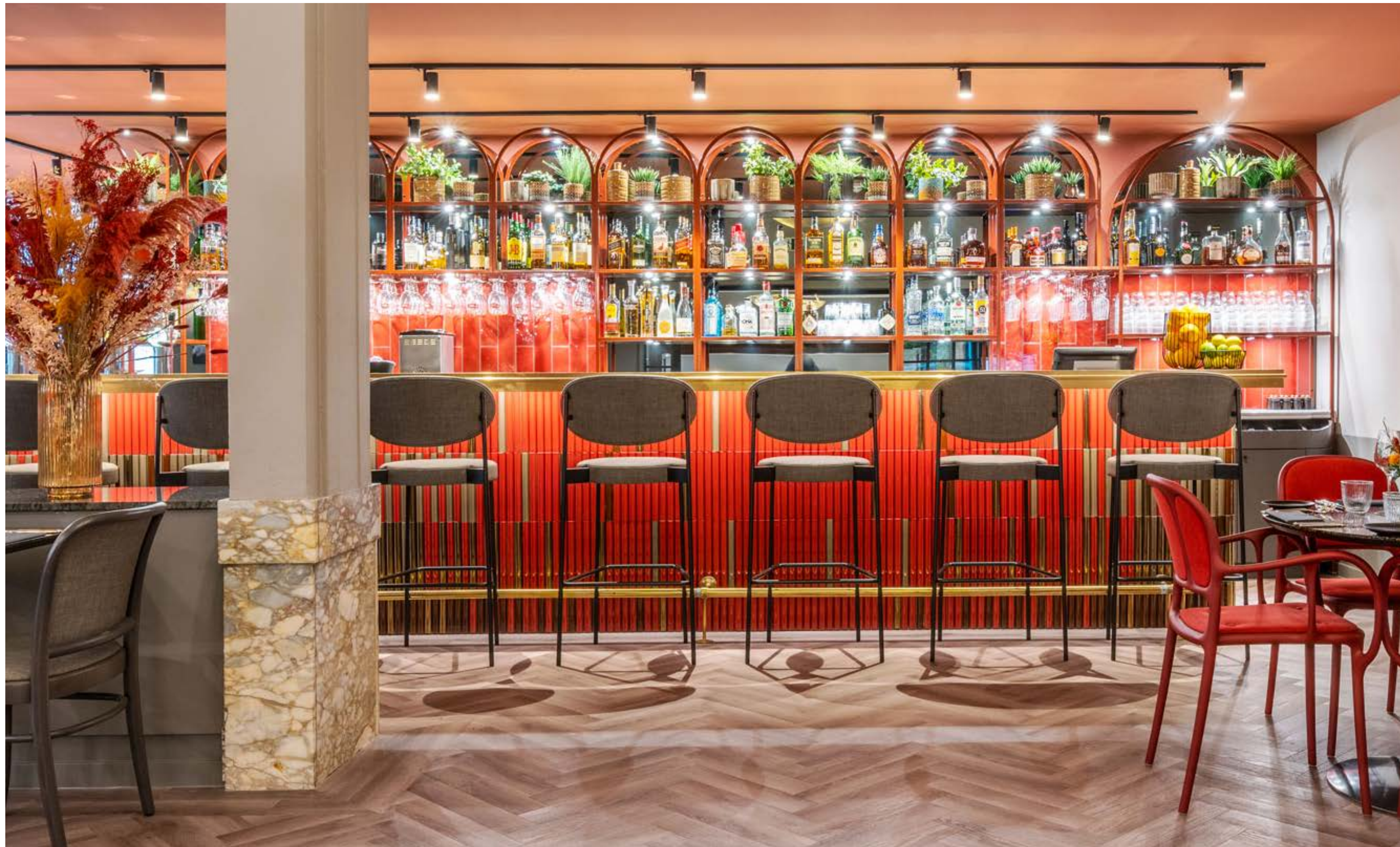

LP49 Rivestimento / Wall: Lapis Rena Intenso: LP300 20x30x2 cm - 8"x12"x0,8", LP305 modulo 3, LP307 modulo 1. Cioccolato: LP145 modulo 3, LP147 modulo 1. Bruno dorato: LP820 20x30x2 cm - 8"x12"x0,8", LP825 modulo 3, LP827 modulo 1. Tortora: LP380 20x30x2 cm - 8"x12"x0,8", LP385 modulo 3, LP387 modulo 1. For "Hilton DoubleTree by Hilton Brussels City" - Project by Technifloor - Belgium



LP27_macro

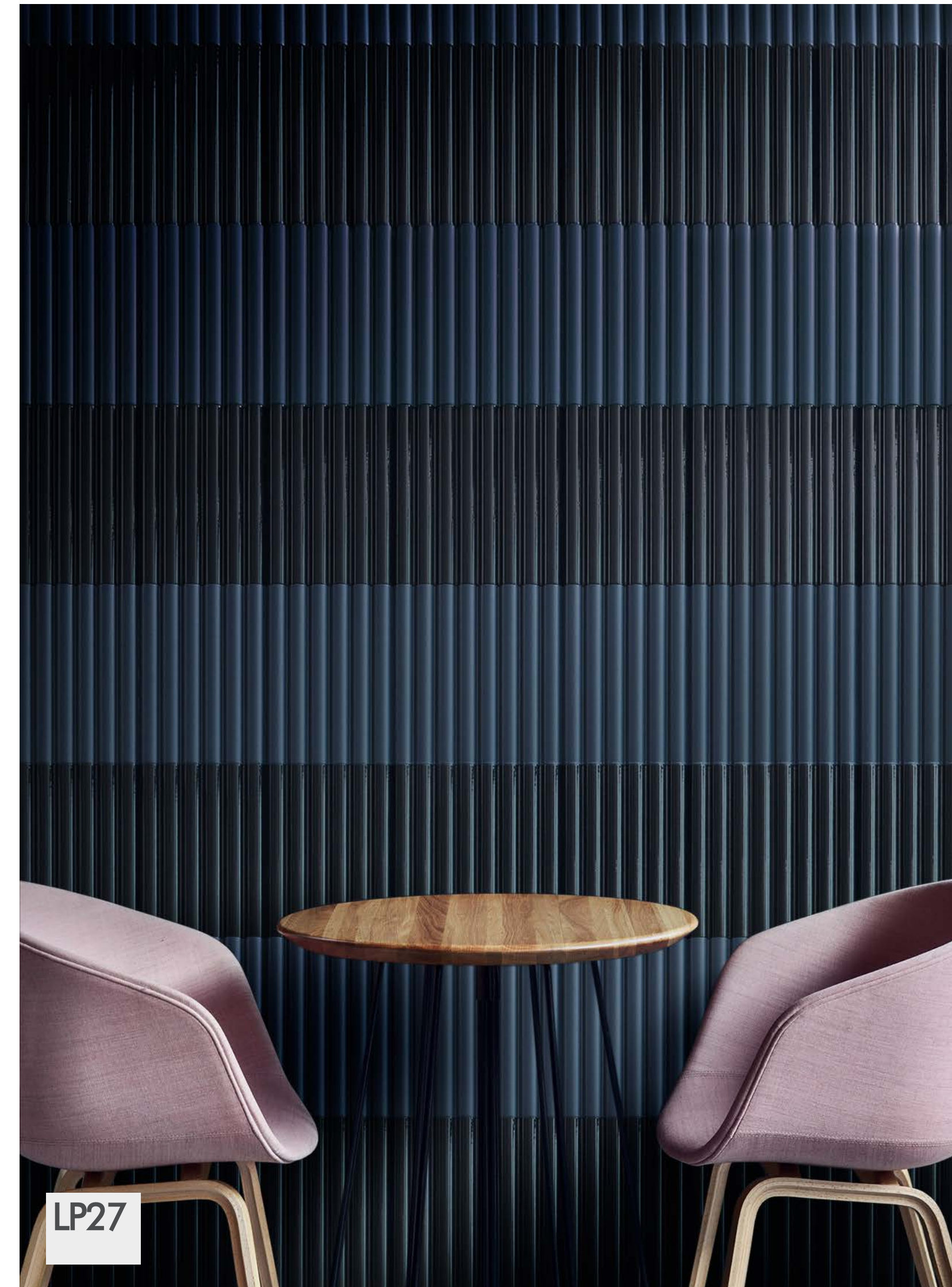

LP27

Rivestimento / Wall: Lapis LP530 Denim silk - LP120 Bleu Nocte craquelé 20x30x2 cm - 8"x12"x0,8"

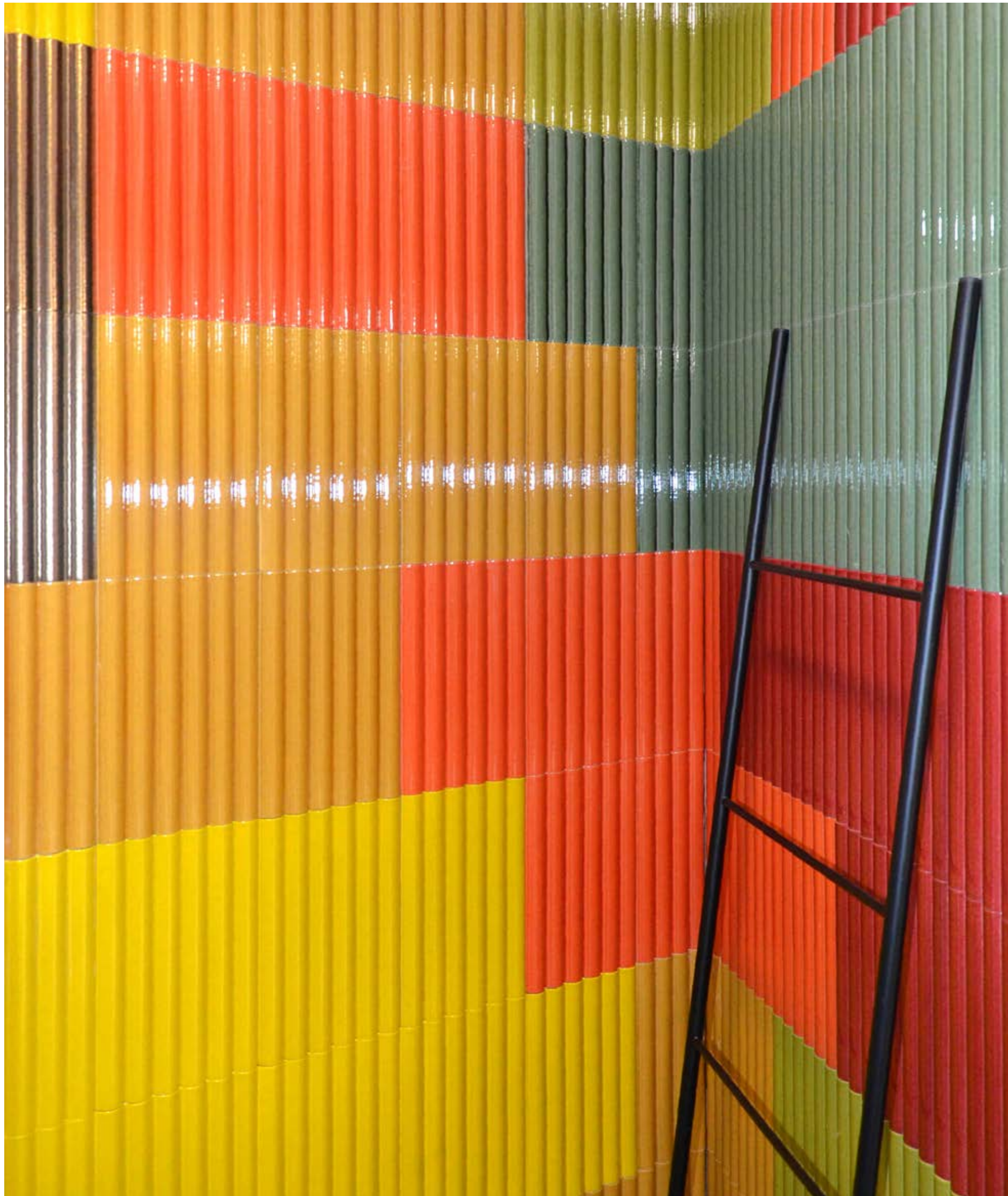

LP23 Rivestimento / Wall: Lapis LP160 Giallo Senape craquelé - LP260 Oasi Intenso craquelé - LP360 Rosso Corallo craquelé - LP300 Rena Intenso craquelé - LP400 Rio Velato craquelé - LP420 Verde Oliva craquelé - LP820 Bruno Dorato metallo 20x30x2 cm - 8"x12"x0,8"
Project by Architetto Marianna Lapadula www.mediterraneoceramica.it

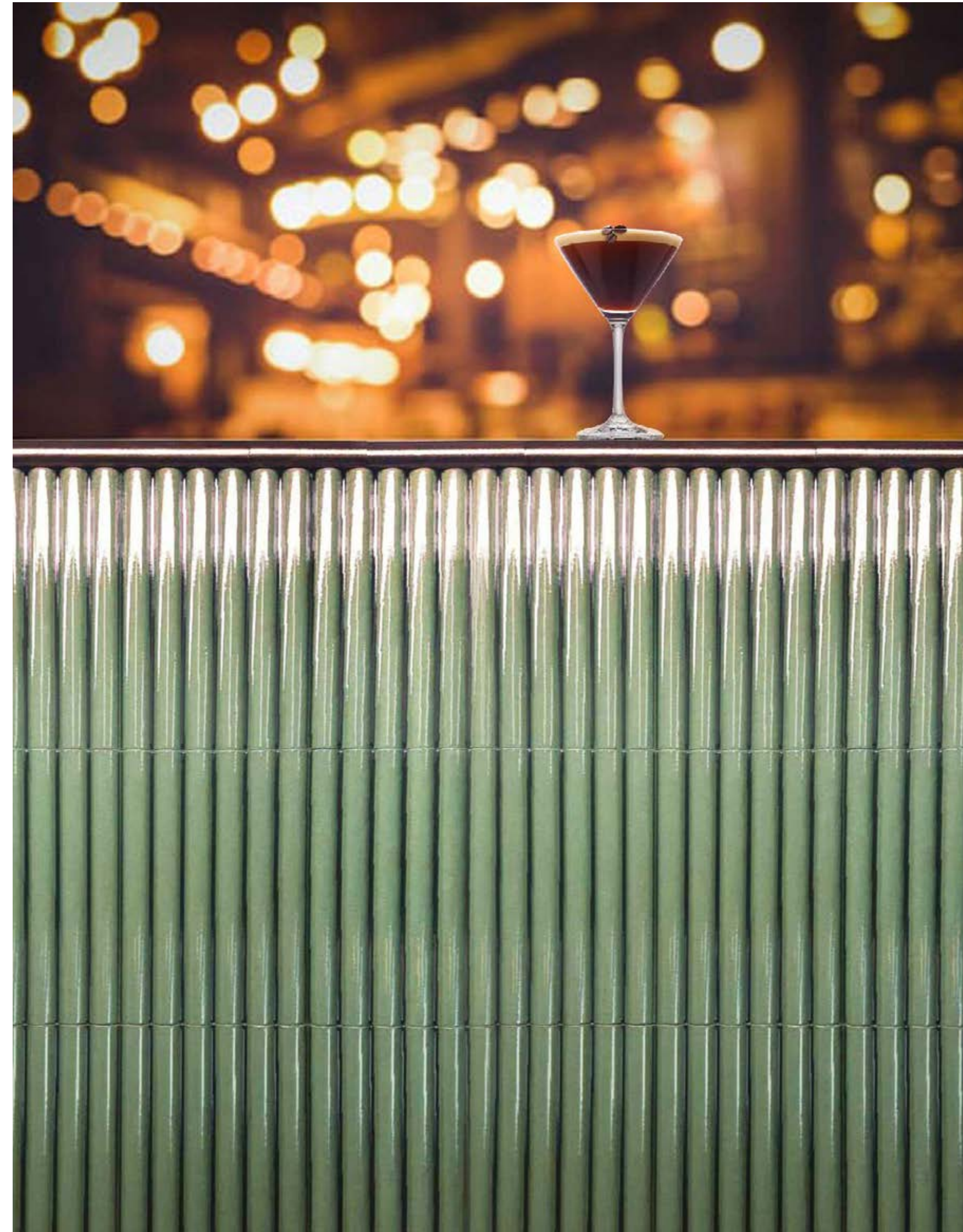

LP24 Rivestimento / Wall: Lapis LP400 Rio Velato craquelé 20x30x2 cm - 8"x12"x0,8"

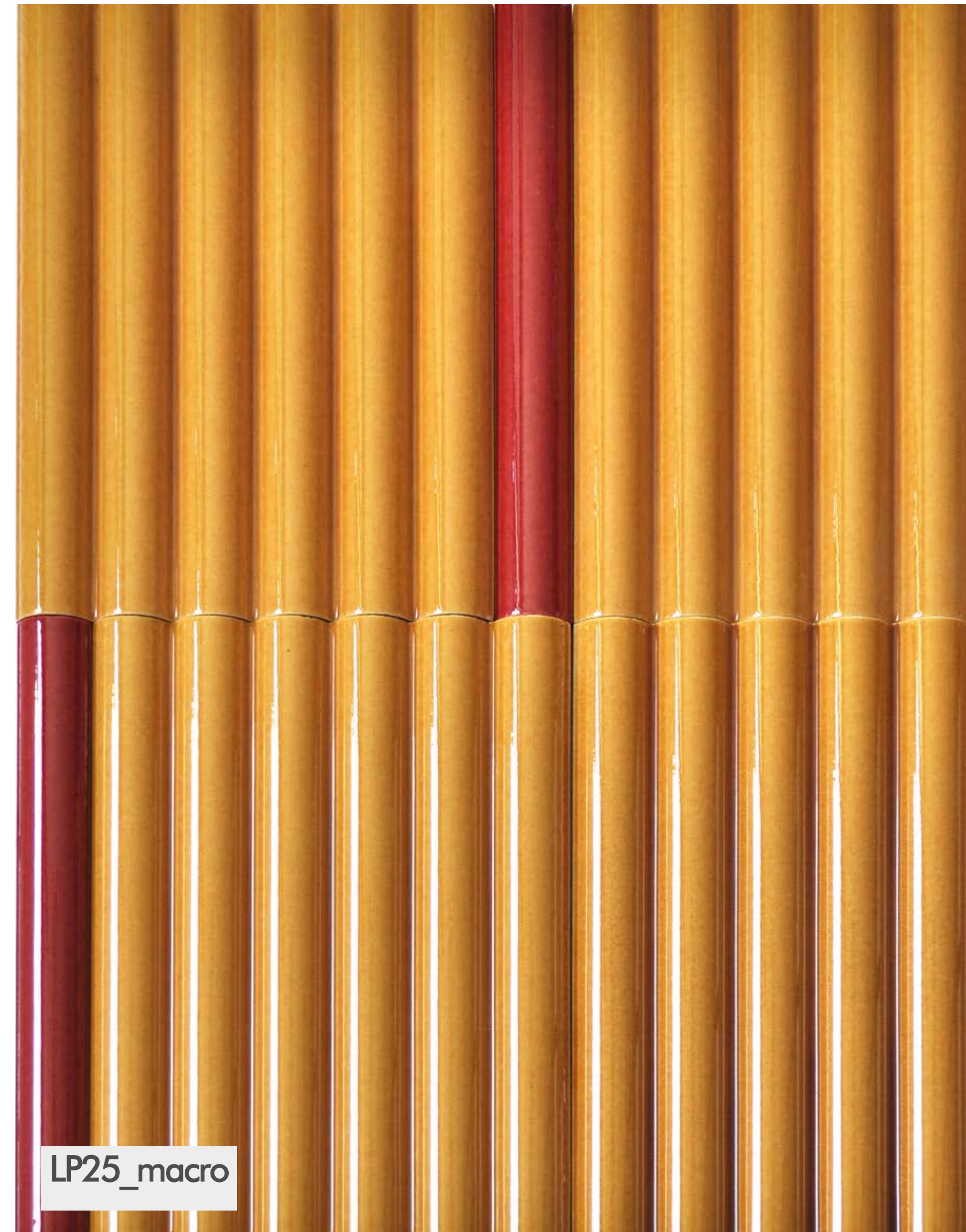

LP25_macro

LP25 Rivestimento / Wall: Lapis LP260 Oasi Intenso craquelé 20x30x2 cm - 8"x12"x0,8" - LP307 Rena Intenso craquelé modulo 1 3,3x30x2 cm - 1,3"x12"x0,8" - Ristorante Jalan, Hong Kong - Cina



LP26 Moodboard food and Lapis - Lapis LP260 Oasi Intenso craquelé - LP360 Rosso Corallo craquelé



LP28 Rivestimento / Wall: Lapis LP550 Cotto Cerato opaco 20x30x2 cm - 8"x12"x0,8"

LP28_macro

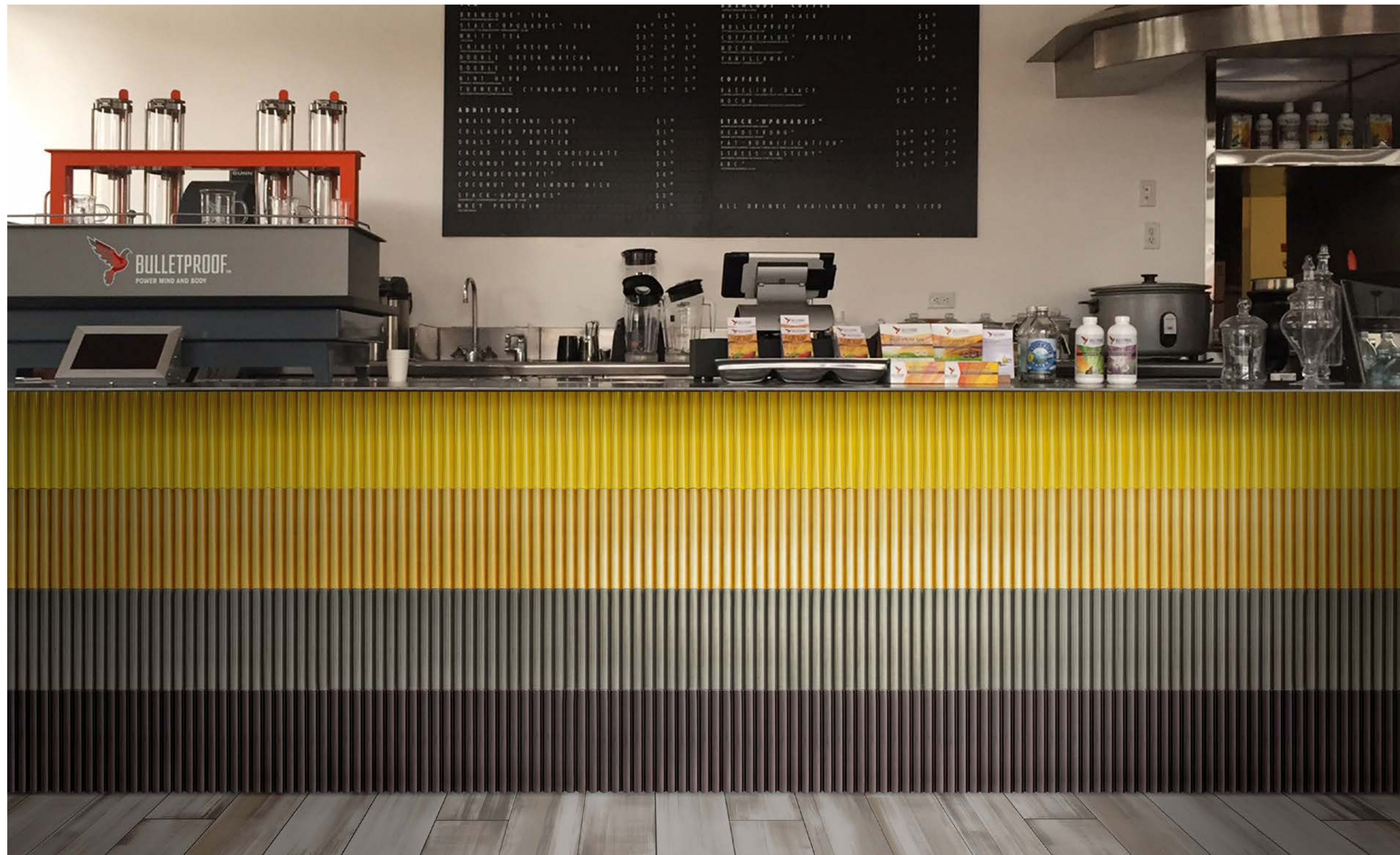

LP29 Rivestimento / Wall: Lapis LP160 Giallo Senape craquelé - LP260 Oasi Intenso craquelé - LP380 Tortora craquelé - LP140 Cioccolato craquelé 20x30x2 cm - 8"x12"x0,8"
 Pavimento / Floor: Canvas J4604 Forest 20x120 cm - 8"x48"

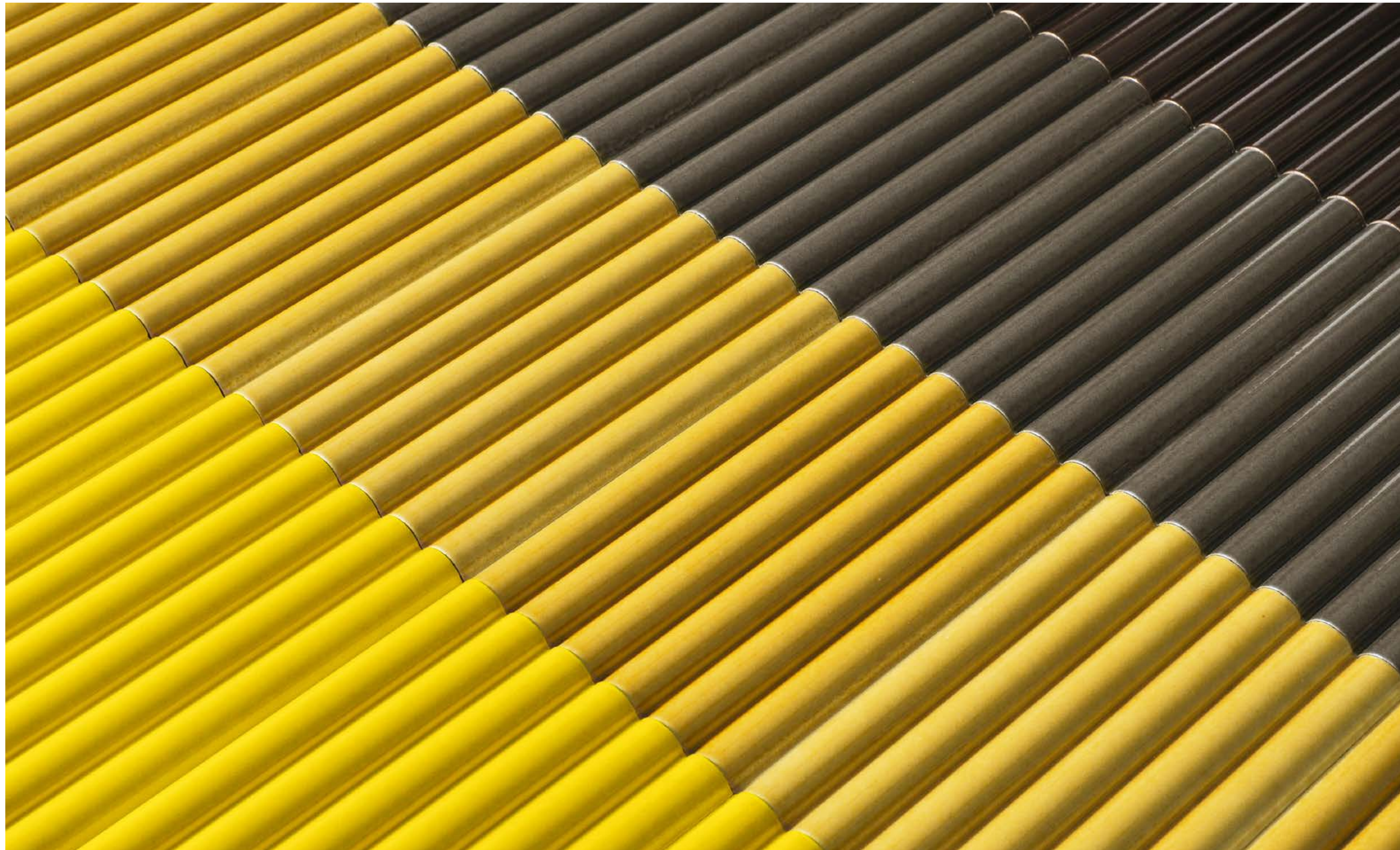

LP29_macro

Lapis LP160 Giallo Senape craquelé - LP260 Oasi Intenso craquelé - LP380 Tortora craquelé - LP140 Cioccolato craquelé 20x30x2 cm - 8"x12"x0,8"



LP30 Rivestimento / Wall: Lapis LP340 Rosa craquelé 20x30x2 cm - 8"x12"x0,8"
 Pavimento / Floor: Stucchi J1451 Bianco 30x30 cm - 12"x12" - Stick W1295 Liquerizia -
 W1165 Lago Intenso - W1285 Gray Stone 4,58x4,85 cm - 2"x2"



LP31 Rivestimento / Wall: Lapis LP340 Rosa craquelé 20x30x2 cm - 8"x12"x0,8" - Lago Intenso craquelé: LP192 modulo
 1 3,3x20x2 cm - 1,3"x8"x0,8" LP191 3,3x10x2 - 1,3"x4"x0,8" - White Moon silk LP533 modulo 1 3,3x20x2 cm
 - 1,3"x8"x0,8" LP532 modulo 1 3,3x10x2 cm - 1,3"x4"x0,8" Pavimento / Floor: Stucchi J1451 Bianco 30x30 cm -
 12"x12" - Stick W1295 Liquerizia - W1165 Lago Intenso - W1285 Gray Stone 4,58x4,85 cm - 2"x2"



Rivestimento / Wall: Lapis LP840 Nero Lustrato metallo madreperla 20x30x2 cm - 8"x12"x0,8"
Pavimento / Floor: Canvas J4604 Forest 20x120 cm - 8"x48"



LP33_macro

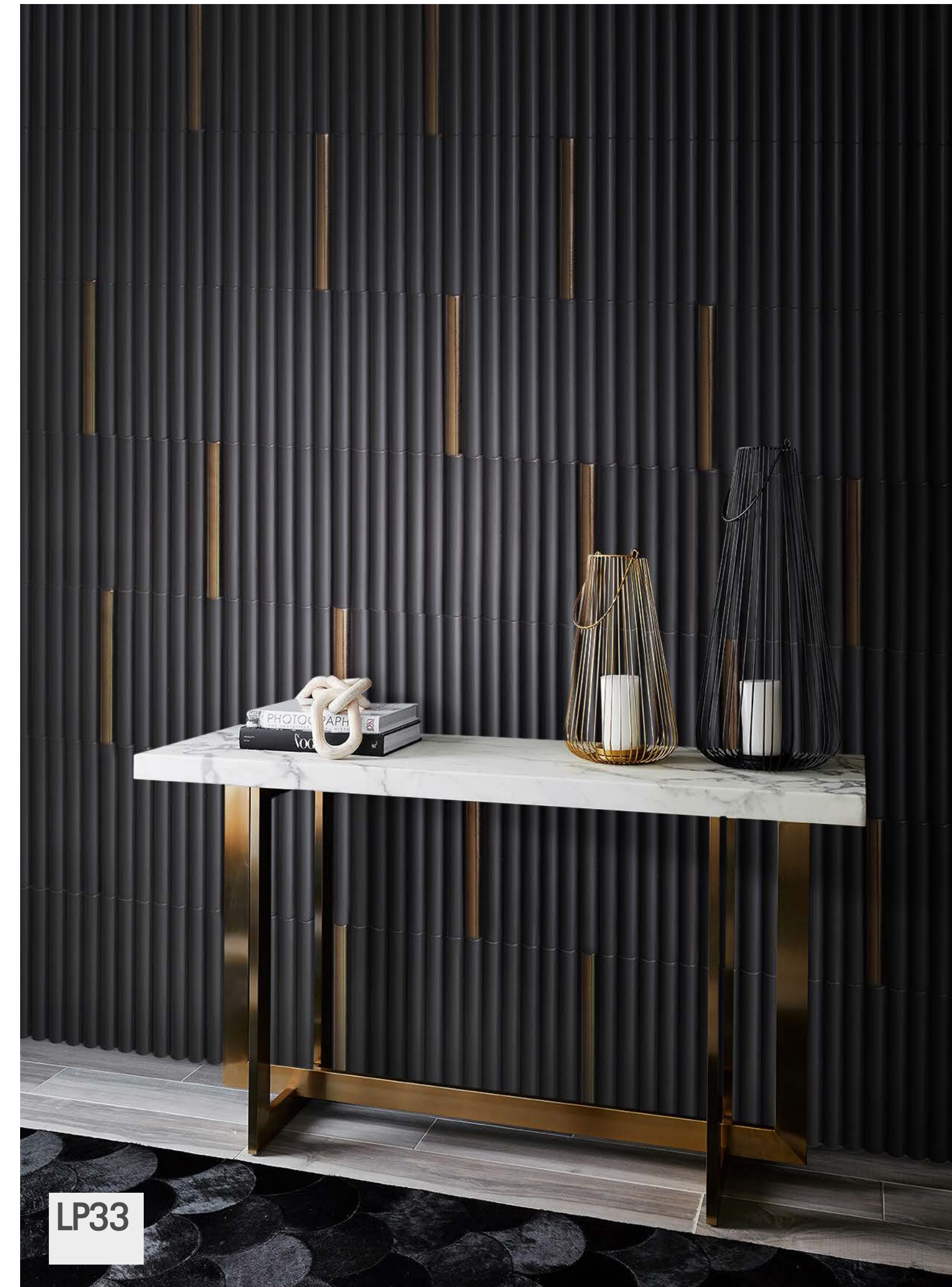

LP33

Rivestimento / Wall: Lapis LP500 Grafite silk 20x30x2 cm - 8"x12"x0,8" - LP827 Bruno Dorato metallo modulo 1 3,3x30x2 cm - 1,3"x12"x0,8"

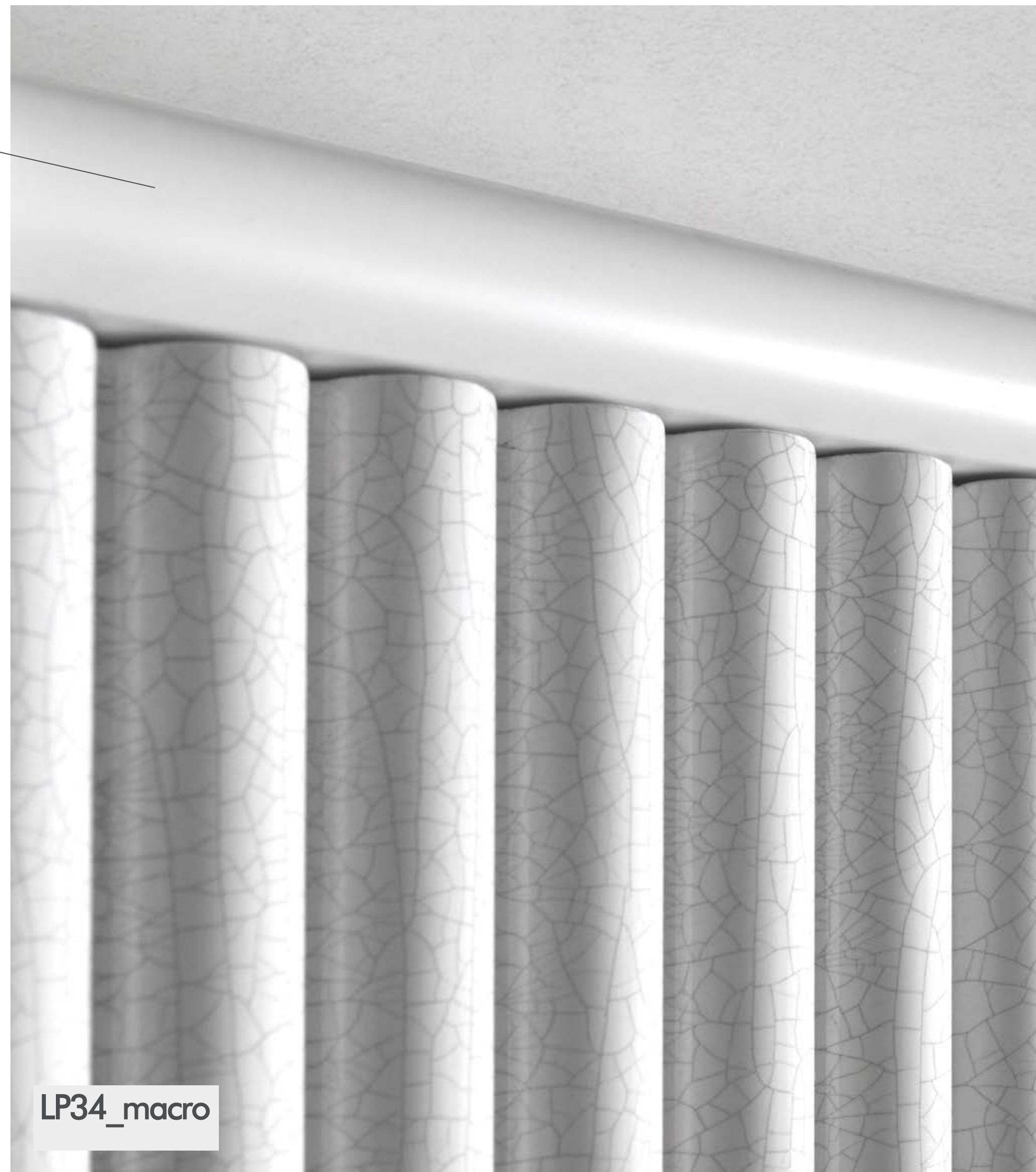
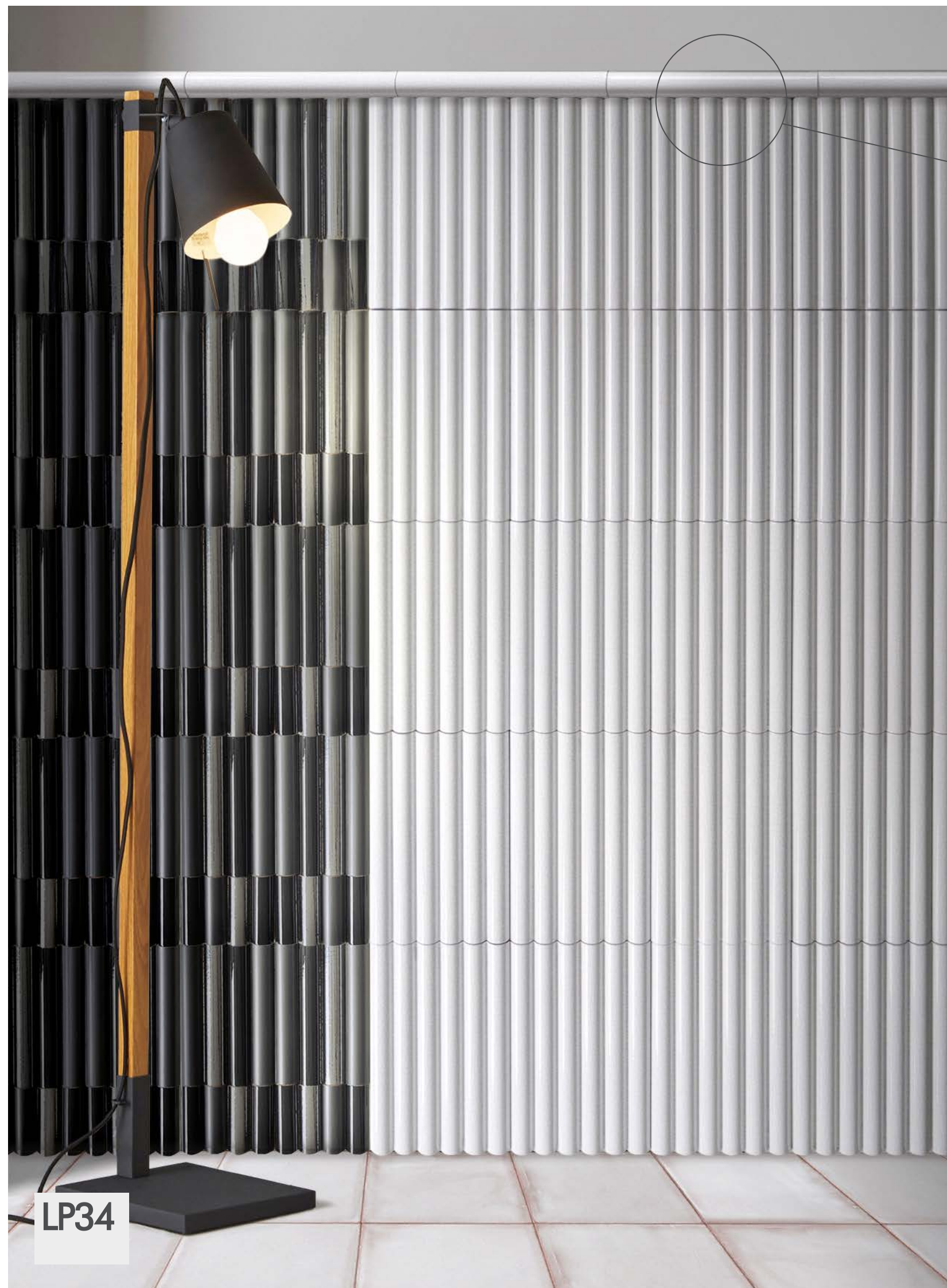

Rivestimento / Wall: Lapis LP480 Bianco Maiolica craquelé 20x30x2 cm - 8"x12"x0,8" - Grafite silk LP512 modulo 1 3,3x20x2 cm - 1,3"x8"x0,8" LP511 modulo 1 3,3x10x2 cm - 1,3"x4"x0,8" - Argento Siderale metallo LP812 modulo 1 3,3x20x2 cm - 1,3"x8"x0,8" LP811 modulo 1 3,3x10x2 cm - 1,3"x4"x0,8" - Nero laccato LP472 modulo 1 3,3x20x2 cm - 1,3"x8"x0,8" LP471 3,3x10x2 cm - 1,3"x4"x0,8" - LP529 Terminale White Moon silk 3x30x3 cm - 1,2"x12"x1,2" Pavimento / Floor: Spatula E3055 Bianco opaco 20x20 cm - 8"x8"



LP35

Rivestimento / Wall: Lapis LP240 Nuvola Intenso craquelé 20x30x2 cm - 8"x12"x0,8" - LP167 Giallo Senape craquelé modulo 1 3,3x30x2 cm - 1,3"x12"x0,8" - LP367 Rosso Corallo craquelé modulo 1 3,3x30x2 cm - 1,3"x12"x0,8"

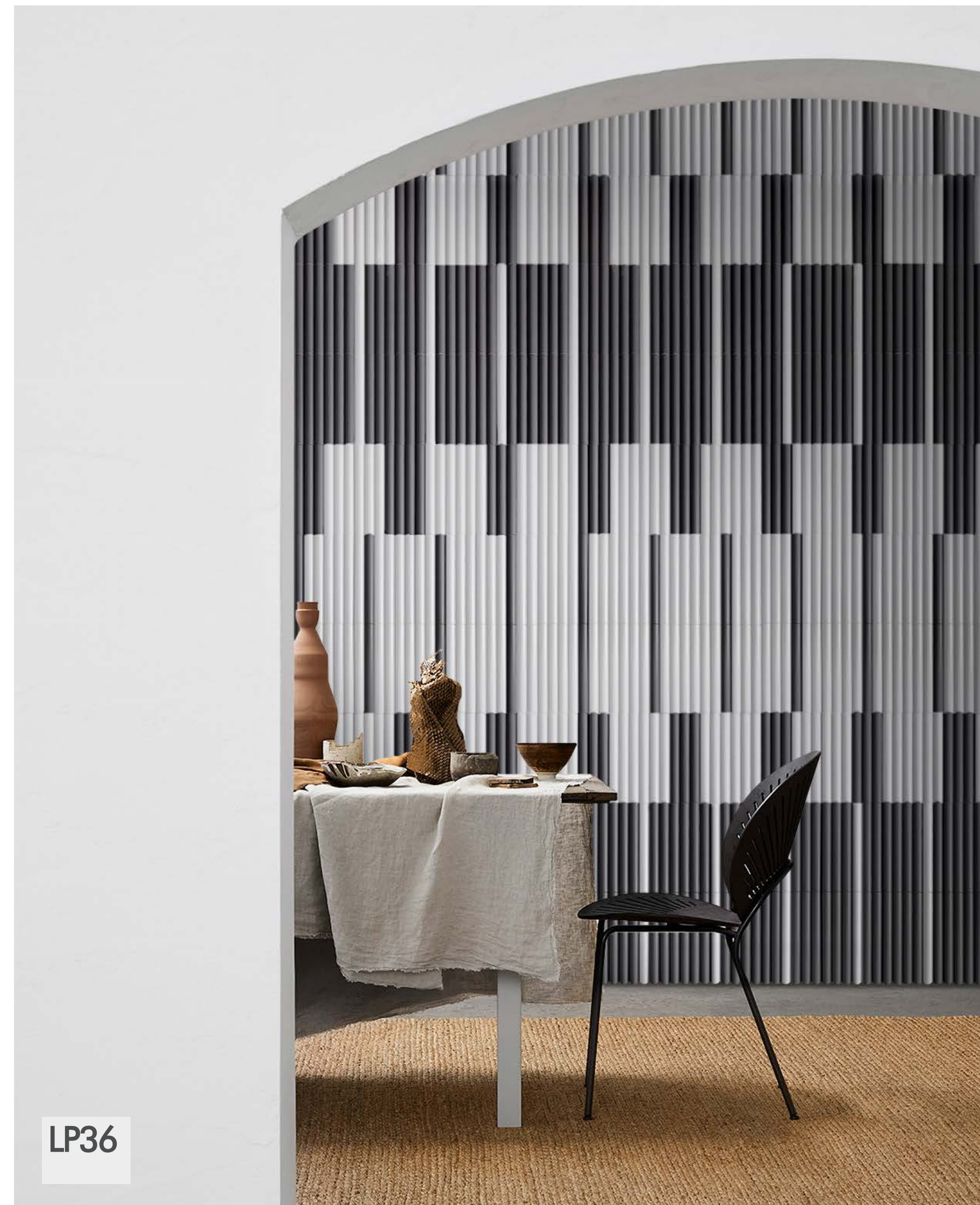

LP36

Rivestimento / Wall: Lapis White Moon silk LP520 20x30x2 cm - 8"x12"x0,8" - LP525 modulo 3 10x30x2 cm - 4"x12"x0,8" - LP527 modulo 1 3,3x30x2 cm - 1,3"x12"x0,8" - Grafite silk LP500 20x30x2 cm - 8"x12"x0,8" - LP505 modulo 3 cm 10x30x2 - 4"x12"x0,8"- LP507 modulo 1 3,3x30x2 cm - 1,3"x12"x0,8"



LP37

Rivestimento / Wall: Lapis LP100 Abisso Velato craquelé 20x30x2 cm - 8"x12"x0,8" - LP167 Giallo Senape modulo 1 3,3x30x2 cm - 1,3"x12"x0,8"



LP38

Rivestimento / Wall: Lapis LP100 Abisso Velato craquelé 20x30x2 cm - 8"x12"x0,8"



LP40 Rivestimento / Wall: Lapis LP520 White Moon silk 20x30x2 cm - 8"x12"x0,8" - LP541 Denim silk LP131 Bleu Notte craquelé - LP231 Lago Velato craquelé modulo 1 3,3x10x2 cm - 1,3"x4"x0,8"



LP46 Rivestimento / Wall: Lapis LP600 Amthyst craquelé 20x30x2 cm - 8"x12"x0,8"



LP39 Rivestimento / Wall: Lapis Lago Limpido craquelé LP205 modulo 3 10x30x2 cm - 4"x12"x0,8" LP207 modulo 1 3,3x30x2 cm - 1,3"x12"x0,8" - Lago Intenso craquelé LP180 20x30x2 cm - 8"x12"x0,8" LP187 modulo 1 3,3x30x2 cm - 1,3"x12"x0,8" - Oceano Velato craquelé LP280 20x30x2 cm - 8"x12"x0,8" - LP287 modulo 1 3,3x30x2 cm - 1,3"x12"x0,8" - Rosa craquelé LP347 modulo 1 3,3x30x2 cm - 1,3"x12"x0,8"



LP22 Rivestimento / Wall: Lapis LP320 Rena Limpido craquelé 20x30x2 cm - 8"x12"x0,8" - LP827 Bruno Dorato metallo modulo 1 3,3x30x2 cm - 1,3"x12"x0,8" - Stick W1100 Rena Limpido 20x120 cm - 8"x48"



LP10 Rivestimento / Wall: Lapis LP440 White Moon craquelé 20x30x2 cm - 8"x12"x0,8" - Stick W1050 Bianco 20x120 cm - 8"x48"
Pavimento / Floor: Stick W1131 Bianco 20x20 cm - 8"x8" - W1291 Liquerizia 20x20 cm - 8"x8"

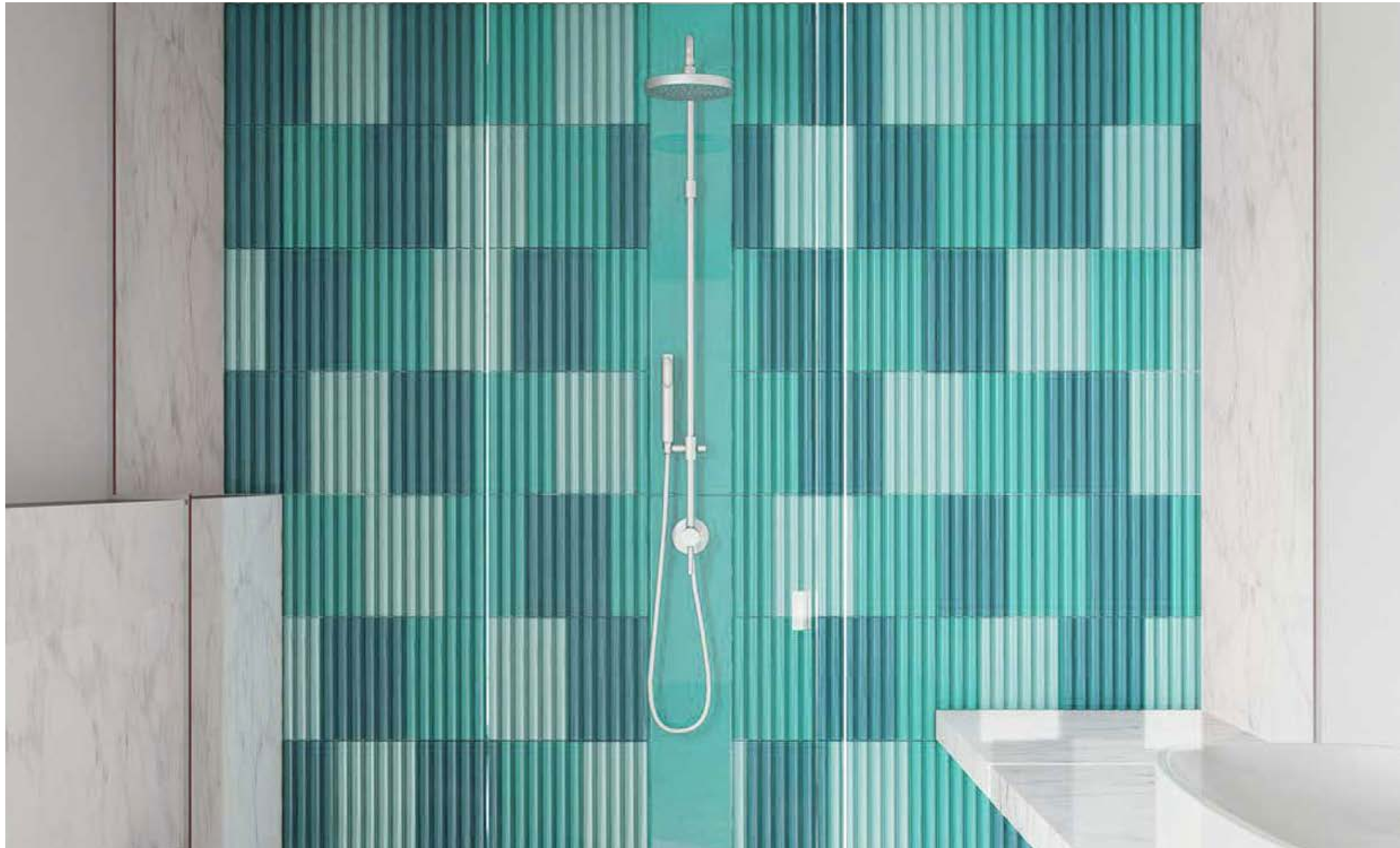

LP14 Rivestimento / Wall: Lapis LP180 Lago Intenso craquelé - LP200 Lago Limpido craquelé - LP220 Lago Velato craquelé 20x30x2 cm - 8"x12"x0,8" Stick W1060 Lago Intenso 20x120 cm - 4"x48"



LP15_macro

Lapis LP180 Lago Intenso craquelé 20x30x2 cm - 8"x12"x0,8" - LP207 Lago Limpido craquelé modulo 1 3,3x30x2 cm - 1,3"x12"x0,8" Stick W1060 Lago Intenso 20x120 cm - 4"x48"



LP13 Rivestimento / Wall: Lapis LP260 Oasi Intenso craquelé 20x30x2 cm - 8"x12"x0,8" - Stick W1095 Oasi Intenso 20x120 cm - 8"x48"
Pavimento / Floor: GEO Pietra 50x50 cm



LP12 Rivestimento / Wall: Lapis Rena Intenso craquelé: LP300 20x30x2 cm - 8"x12"x0,8" LP307 3,3x30x2 cm - 1,3"x12"x0,8" Stick W1105 Rena Intenso 20x120 cm - 8"x48"
Pavimento / Floor: GEO Pietra 50x50 cm



LP41 Forniture: Lapis LP165 Giallo Senape craquelé modulo 3 10x30x2 cm - 4"x12"x0,8" - LP225 Lago Velato craquelé modulo 3 10x30x2 cm - 4"x12"x0,8" - LP365 Rosso Corallo craquelé modulo 3 10x30x2 cm - 4"x12"x0,8" - Project by Architect Toni Mattioli



LP42 Furniture: Lapis LP365 Rosso Corallo craquelé modulo 3 10x30x2 cm - 4"x12"x0,8"
LP225 Lago Velato craquelé modulo 3 10x30x2 cm - 4"x12"x0,8" - Project by Architect Toni Mattioli

LP43 Furniture: Lapis LP305 Rena Intenso craquelé modulo 3 10x30x2 cm - 4"x12"x0,8"
Project by Architect Toni Mattioli



LP44 Furniture: Lapis LP165 Giallo Senape craquelé modulo 3 10x30x2 cm - 4"x12"x0,8"
Project by Architect Toni Mattioli



LP45 Furniture: Lapis LP307 Rena Intenso craquelé modulo 1 3,3x30x2 cm - 1,3"x12"x0,8"
White Moon silk LP525 modulo 3 10x30x2 cm - 4"x12"x0,8" - LP527 modulo 1 3,3x30x2 cm - 1,3"x12"x0,8"

1 FORMATO SIZE

FINITURE FINISHING

PEZZI SPECIALI SPECIAL PIECES

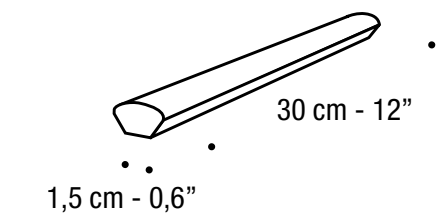
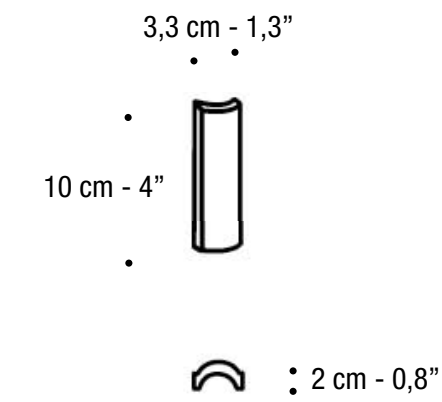
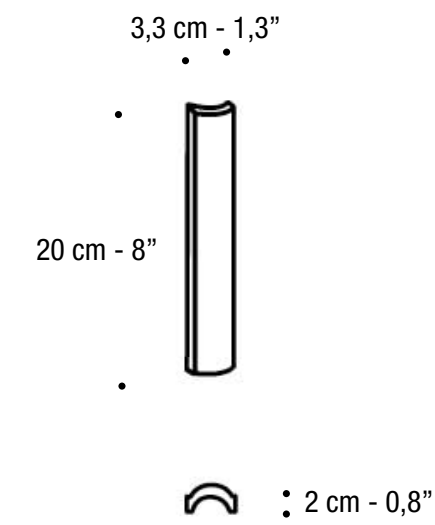
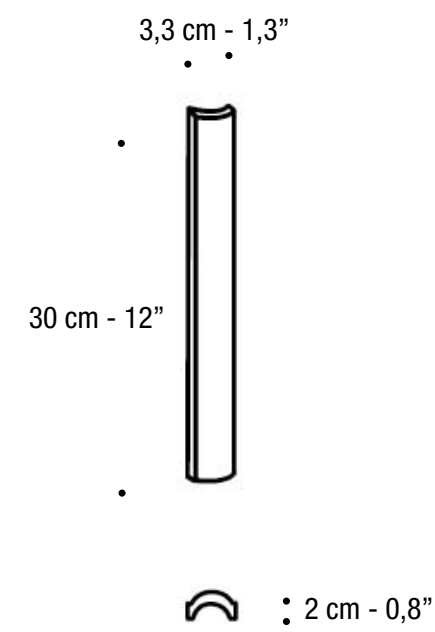
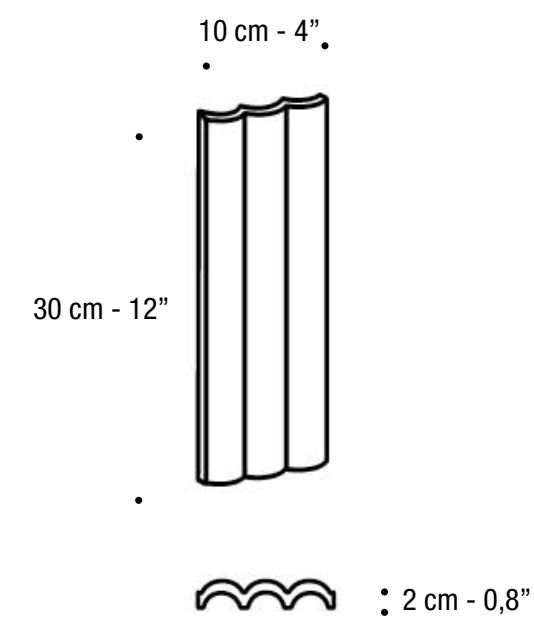
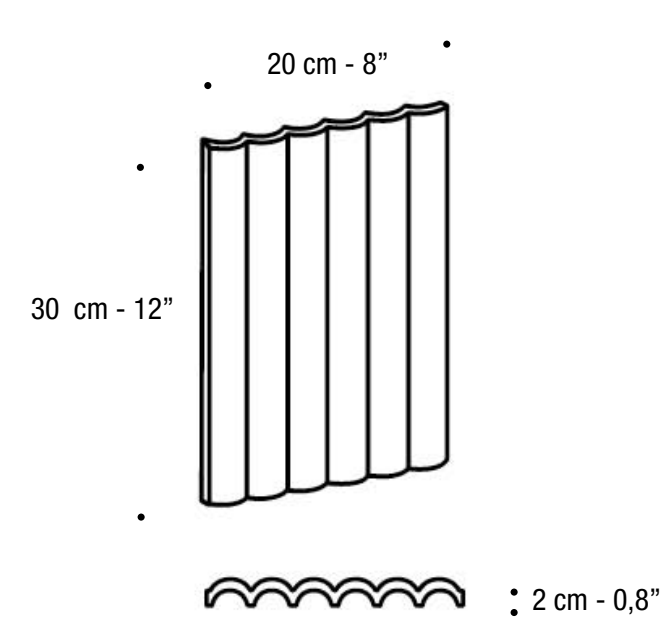

ABISSO VELATO craquelé



LP100
20x30x2 cm - 8"x12"x0,8"



LP105 modulo 3
10x30x2 cm - 4"x12"x0,8"



LP107 modulo 1
3,3x30x2 cm - 1,3"x12"x0,8"



LP112 modulo 1
3,3x20x2 cm - 1,3"x8"x0,8"



LP111 modulo 1
3,3x10x2 cm - 1,3"x4"x0,8"

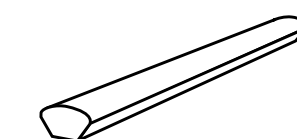

LP110 quartino
1,5x30 cm - 0,6"x12"

AMTHYST craquelé



LP600
20x30x2 cm - 8"x12"x0,8"



LP605 modulo 3
10x30x2 cm - 4"x12"x0,8"

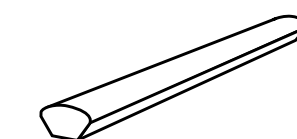

LP610 quartino
1,5x30 cm - 0,6"x12"

BIANCO MAIOLICA craquelé



LP480
20x30x2 cm - 8"x12"x0,8"



LP485 modulo 3
10x30x2 cm - 4"x12"x0,8"



LP487 modulo 1
3,3x30x2 cm - 1,3"x12"x0,8"



LP492 modulo 1
3,3x20x2 cm - 1,3"x8"x0,8"



LP491 modulo 1
3,3x10x2 cm - 1,3"x4"x0,8"

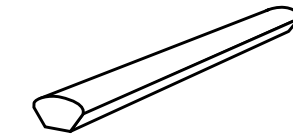

LP490 quartino
1,5x30 cm - 0,6"x12"

BLEU NOTTE craquelé



LP120
20x30x2 cm - 8"x12"x0,8"



LP125 modulo 3
10x30x2 cm - 4"x12"x0,8"



LP127 modulo 1
3,3x30x2 cm - 1,3"x12"x0,8"



LP132 modulo 1
3,3x20x2 cm - 1,3"x8"x0,8"



LP131 modulo 1
3,3x30x2 cm - 1,3"x4"x0,8"

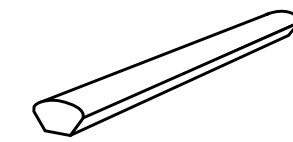

LP130 quartino
1,5x30 cm - 0,6"x12"

CIOCCOLATO craquelé



LP140
20x30x2 cm - 8"x12"x0,8"



LP145 modulo 3
10x30x2 cm - 4"x12"x0,8"



LP147 modulo 1
3,3x30x2 cm - 1,3"x12"x0,8"



LP152 modulo 1
3,3x20x2 cm - 1,3"x8"x0,8"



LP151 modulo 1
3,3x10x2 cm - 1,3"x4"x0,8"

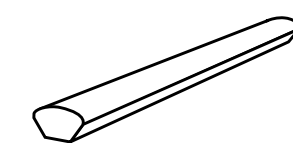

LP150 quartino
1,5x30 cm - 0,6"x12"

GIALLO SENAPE craquelé



LP160
20x30x2 cm - 8"x12"x0,8"



LP165 modulo 3
10x30x2 cm - 4"x12"x0,8"



LP167 modulo 1
3,3x30x2 cm - 1,3"x12"x0,8"



LP172 modulo 1
3,3x20x2 cm - 1,3"x8"x0,8"



LP171 modulo 1
3,3x10x2 cm - 1,3"x4"x0,8"

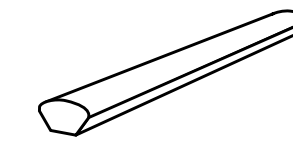

LP170 quartino
1,5x30 cm - 0,6"x12"

LAGO INTENSO craquelé



LP180
20x30x2 cm - 8"x12"x0,8"



LP185 modulo 3
10x30x2 cm - 4"x12"x0,8"



LP187 modulo 1
3,3x30x2 cm - 1,3"x12"x0,8"



LP192 modulo 1
3,3x20x2 cm - 1,3"x8"x0,8"



LP191 modulo 1
3,3x10x2 cm - 1,3"x4"x0,8"

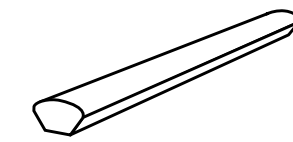

LP190 quartino
1,5x30 cm - 0,6"x12"

LAGO LIMPIDO craquelé



LP200
20x30x2 cm - 8"x12"x0,8"



LP205 modulo 3
10x30x2 cm - 4"x12"x0,8"



LP207 modulo 1
3,3x30x2 cm - 1,3"x12"x0,8"



LP212 modulo 1
3,3x20x2 cm - 1,3"x8"x0,8"



LP211 modulo 1
3,3x10x2 cm - 1,3"x4"x0,8"

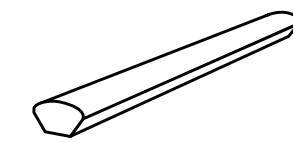

LP210 quartino
1,5x30 cm - 0,6"x12"

LAGO VELATO craquelé



LP220
20x30x2 cm - 8"x12"x0,8"



LP225 modulo 3
10x30x2 cm - 4"x12"x0,8"



LP227 modulo 1
3,3x30x2 cm - 1,3"x12"x0,8"



LP232 modulo 1
3,3x20x2 cm - 1,3"x8"x0,8"



LP231 modulo 1
3,3x10x2 cm - 1,3"x4"x0,8"

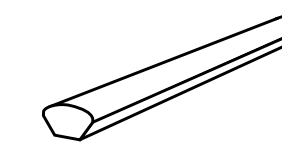

LP230 quartino
1,5x30 cm - 0,6"x12"

NERO laccato



LP460
20x30x2 cm - 8"x12"x0,8"



LP465 modulo 3
10x30x2 cm - 4"x12"x0,8"



LP467 modulo 1
3,3x30x2 cm - 1,3"x12"x0,8"



LP472 modulo 1
3,3x20x2 cm - 1,3"x8"x0,8"



LP471 modulo 1
3,3x10x2 cm - 1,3"x4"x0,8"

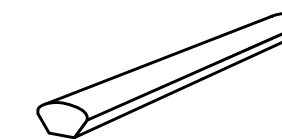

LP470 quartino
1,5x30 cm - 0,6"x12"

NUVOLA INTENSO craquelé



LP240
20x30x2 cm - 8"x12"x0,8"



LP245 modulo 3
10x30x2 cm - 4"x12"x0,8"



LP247 modulo 1
3,3x30x2 cm - 1,3"x12"x0,8"



LP252 modulo 1
3,3x20x2 cm - 1,3"x8"x0,8"



LP251 modulo 1
3,3x10x2 cm - 1,3"x4"x0,8"

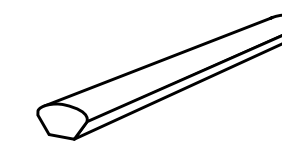

LP250 quartino
1,5x30 cm - 0,6"x12"

OASI INTENSO craquelé



LP260
20x30x2 cm - 8"x12"x0,8"



LP265 modulo 3
10x30x2 cm - 4"x12"x0,8"



LP267 modulo 1
3,3x30x2 cm - 1,3"x12"x0,8"



LP272 modulo 1
3,3x20x2 cm - 1,3"x8"x0,8"



LP271 modulo 1
3,3x10x2 cm - 1,3"x4"x0,8"

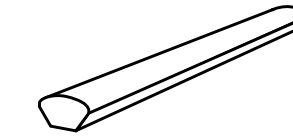

LP270 quartino
1,5x30 cm - 0,6"x12"

OCEANO VELATO craquelé



LP280
20x30x2 cm - 8"x12"x0,8"



LP285 modulo 3
10x30x2 cm - 4"x12"x0,8"



LP287 modulo 1
3,3x30x2 cm - 1,3"x12"x0,8"



LP292 modulo 1
3,3x20x2 cm - 1,3"x8"x0,8"



LP291 modulo 1
3,3x10x2 cm - 1,3"x4"x0,8"

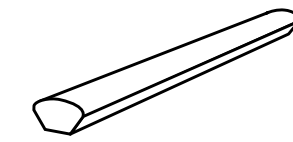

LP290 quartino
1,5x30 cm - 0,6"x12"

RENA INTENSO craquelé



LP300
20x30x2 cm - 8"x12"x0,8"



LP305 modulo 3
10x30x2 cm - 4"x12"x0,8"



LP307 modulo 1
3,3x30x2 cm - 1,3"x12"x0,8"



LP312 modulo 1
3,3x20x2 cm - 1,3"x8"x0,8"



LP311 modulo 1
3,3x10x2 cm - 1,3"x4"x0,8"

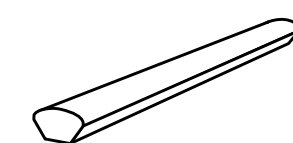

LP310 quartino
1,5x30 cm - 0,6"x12"

RENA LIMPIDO craquelé



LP320
20x30x2 cm - 8"x12"x0,8"



LP325 modulo 3
10x30x2 cm - 4"x12"x0,8"



LP327 modulo 1
3,3x30x2 cm - 1,3"x12"x0,8"



LP332 modulo 1
3,3x20x2 cm - 1,3"x8"x0,8"



LP331 modulo 1
3,3x10x2 cm - 1,3"x4"x0,8"

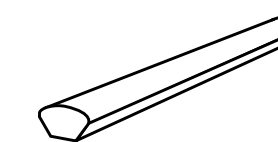

LP330 quartino
1,5x30 cm - 0,6"x12"

RIO VELATO craquelé



LP400
20x30x2 cm - 8"x12"x0,8"



LP405 modulo 3
10x30x2 cm - 4"x12"x0,8"



LP407 modulo 1
3,3x30x2 cm - 1,3"x12"x0,8"



LP412 modulo 1
3,3x20x2 cm - 1,3"x8"x0,8"



LP411 modulo 1
3,3x10x2 cm - 1,3"x4"x0,8"

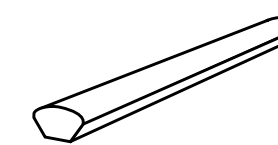

LP410 quartino
1,5x30 cm - 0,6"x12"

ROSA craquelé



LP340
20x30x2 cm - 8"x12"x0,8"



LP345 modulo 3
10x30x2 cm - 4"x12"x0,8"



LP347 modulo 1
3,3x30x2 cm - 1,3"x12"x0,8"



LP352 modulo 1
3,3x20x2 cm - 1,3"x8"x0,8"



LP351 modulo 1
3,3x10x2 cm - 1,3"x4"x0,8"

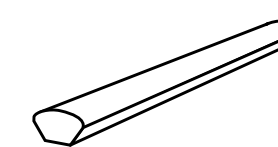

LP350 quartino
1,5x30 cm - 0,6"x12"

ROSSO CORALLO craquelé



LP360
20x30x2 cm - 8"x12"x0,8"



LP365 modulo 3
10x30x2 cm - 4"x12"x0,8"



LP367 modulo 1
3,3x30x2 cm - 1,3"x12"x0,8"



LP372 modulo 1
3,3x20x2 cm - 1,3"x8"x0,8"



LP371 modulo 1
3,3x10x2 cm - 1,3"x4"x0,8"

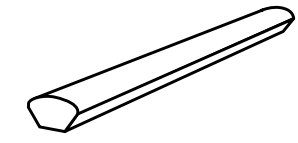

LP370 quartino
1,5x30 cm - 0,6"x12"

TORTORA craquelé



LP380
20x30x2 cm - 8"x12"x0,8"



LP385 modulo 3
10x30x2 cm - 4"x12"x0,8"



LP387 modulo 1
3,3x30x2 cm - 1,3"x12"x0,8"



LP392 modulo 1
3,3x20x2 cm - 1,3"x8"x0,8"



LP391 modulo 1
3,3x10x2 cm - 1,3"x4"x0,8"

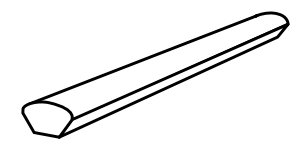

LP390 quartino
1,5x30 cm - 0,6"x12"

VERDE OLIVA craquelé



LP420
20x30x2 cm - 8"x12"x0,8"



LP425 modulo 3
10x30x2 cm - 4"x12"x0,8"



LP427 modulo 1
3,3x30x2 cm - 1,3"x12"x0,8"



LP432 modulo 1
3,3x20x2 cm - 1,3"x8"x0,8"



LP431 modulo 1
3,3x10x2 cm - 1,3"x4"x0,8"

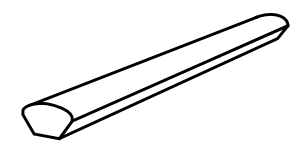

LP430 quartino
1,5x30 cm - 0,6"x12"

WHITE MOON craquelé



LP440
20x30x2 cm - 8"x12"x0,8"



LP445 modulo 3
10x30x2 cm - 4"x12"x0,8"



LP447 modulo 1
3,3x30x2 cm - 1,3"x12"x0,8"



LP452 modulo 1
3,3x20x2 cm - 1,3"x8"x0,8"



LP451 modulo 1
3,3x10x2 cm - 1,3"x4"x0,8"

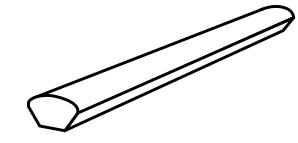

LP450 quartino
1,5x30 cm - 0,6"x12"

COTTO CERATO opaco



LP550
20x30x2 cm - 8"x12"x0,8"



LP555 modulo 3
10x30x2 cm - 4"x12"x0,8"



LP557 modulo 1
3,3x30x2 cm - 1,3"x12"x0,8"



LP562 modulo 1
3,3x20x2 cm - 1,3"x8"x0,8"



LP561 modulo 1
3,3x10x2 cm - 1,3"x4"x0,8"

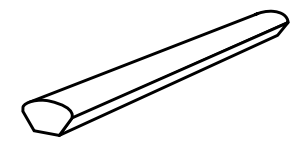

LP560 quartino
1,5x30 cm - 0,6"x12"

DENIM silk



LP530
20x30x2 cm - 8"x12"x0,8"



LP535 modulo 3
10x30x2 cm - 4"x12"x0,8"



LP537 modulo 1
3,3x30x2 cm - 1,3"x12"x0,8"



LP542 modulo 1
3,3x20x2 cm - 1,3"x8"x0,8"



LP541 modulo 1
3,3x10x2 cm - 1,3"x4"x0,8"

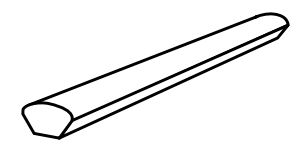

LP540 quartino
1,5x30 cm - 0,6"x12"

GRAFITE *silk*



LP500
20x30x2 cm - 8"x12"x0,8"



LP505 modulo 3
10x30x2 cm - 4"x12"x0,8"



LP507 modulo 1
3,3x30x2 cm - 1,3"x12"x0,8"



LP512 modulo 1
3,3x20x2 cm - 1,3"x8"x0,8"



LP511 modulo 1
3,3x10x2 cm - 1,3"x4"x0,8"

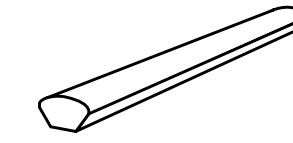

LP510 quartino
1,5x30 cm - 0,6"x12"

WHITE MOON *silk*



LP520
20x30x2 cm - 8"x12"x0,8"



LP525 modulo 3
10x30x2 cm - 4"x12"x0,8"



LP527 modulo 1
3,3x30x2 cm - 1,3"x12"x0,8"



LP533 modulo 1
3,3x20x2 cm - 1,3"x8"x0,8"



LP532 modulo 1
3,3x10x2 cm - 1,3"x4"x0,8"

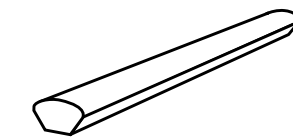

LP531 quartino
1,5x30 cm - 0,6"x12"

ARGENTO SIDERALE *metallo*



LP800
20x30x2 cm - 8"x12"x0,8"



LP805 modulo 3
10x30x2 cm - 4"x12"x0,8"



LP807 modulo 1
3,3x30x2 cm - 1,3"x12"x0,8"



LP812 modulo 1
3,3x20x2 cm - 1,3"x8"x0,8"



LP811 modulo 1
3,3x10x2 cm - 1,3"x4"x0,8"

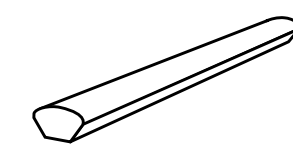

LP810 quartino
1,5x30 cm - 0,6"x12"

BRUNO DORATO metallo



LP820
20x30x2 cm - 8"x12"x0,8"



LP825 modulo 3
10x30x2 cm - 4"x12"x0,8"



LP827 modulo 1
3,3x30x2 cm - 1,3"x12"x0,8"



LP833 modulo 1
3,3x20x2 cm - 1,3"x8"x0,8"



LP832 modulo 1
3,3x10x2 cm - 1,3"x4"x0,8"

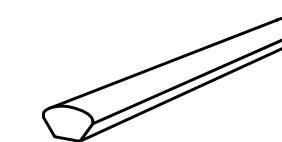

LP831 quartino
1,5x30 cm - 0,6"x12"

NERO LUSTRATO metallo madreperla



LP840
20x30x2 cm - 8"x12"x0,8"



LP845 modulo 3
10x30x2 cm - 4"x12"x0,8"



LP847 modulo 1
3,3x30x2 cm - 1,3"x12"x0,8"



LP852 modulo 1
3,3x20x2 cm - 1,3"x8"x0,8"



LP851 modulo 1
3,3x10x2 cm - 1,3"x4"x0,8"

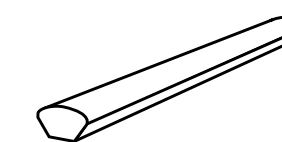

LP850 quartino
1,5x30 cm - 0,6"x12"

TERMINALE

ENDING PIECE

Terminale di chiusura 3x30x3 cm - 1,2"x12"x1,2"
Ending piece

Colori disponibili:
Available colours



NERO laccato
LP469



COTTO CERATO opaco
LP559



GRAFITE silk
LP509



WHITE MOON silk
LP529



ARGENTO SIDERALE metallo
LP809



BRUNO DORATO metallo
LP829

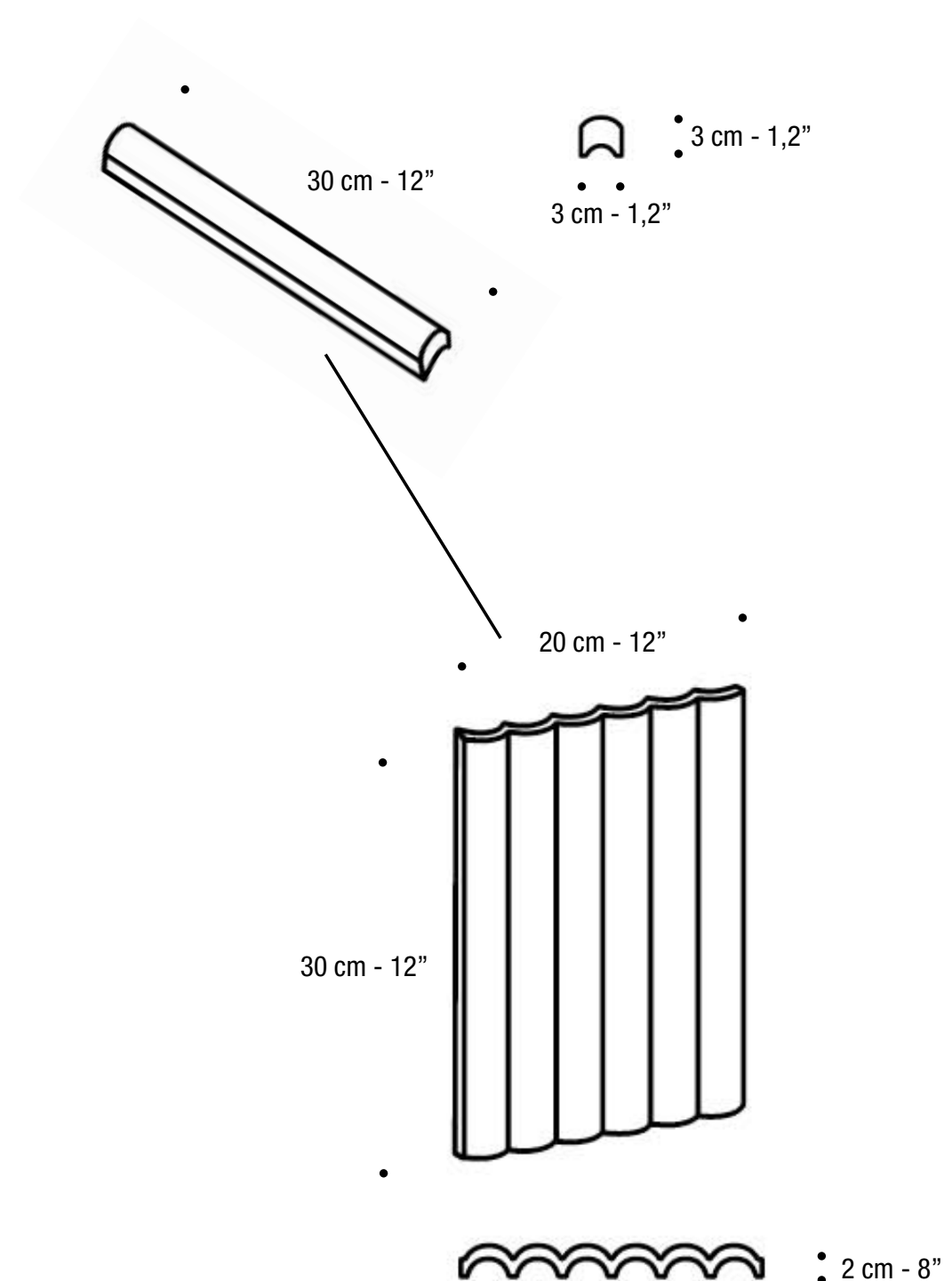

LAPIS POSA DI UN ANGOLO ESTERNO LAYING ON AN EXTERNAL CORNER

A

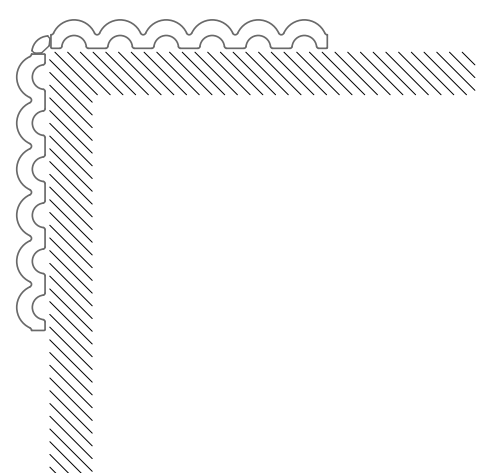

B

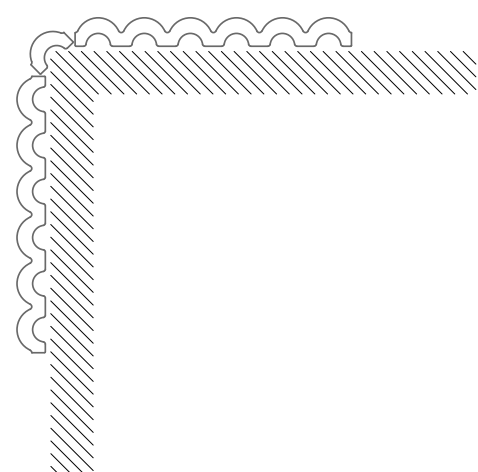

Per rivestire un angolo esterno, è possibile utilizzare il pezzo speciale “quartino” **(A)**, che raccorda perfettamente le piastrelle posate a 90°. In alternativa, è possibile utilizzare anche il “modulo 1” **(B)**, posizionato direttamente nell’angolo della colonna da rivestire. (Si consiglia di stuccare la fessura creata tra il “modulo 1” e le piastrelle affianco).

To cover an external corner, it is possible to use the special “quartino” **(A)** piece, which perfectly connects the tiles laid at 90°. Otherwise, it is also possible to use the “modulo 1” **(B)**, installed directly in the corner of the column to be covered. (We suggest to grout the joint between the “modulo 1” and the other tiles beside it).

Pour recouvrir un angle extérieur, il est possible d’utiliser la pièce spéciale « quartino » **(A)**, qui relie parfaitement les carreaux posés à 90°. Il est également possible d’utiliser le « modulo 1 » **(B)**, installé directement sur le coin de la colonne à revêtir. (On vous conseille de combler les joints entre le « modulo 1 » et les carreaux posés tout à côté).

Um eine Außenecke abzudecken, kann das spezielle Stück „quartino“ **(A)** verwendet werden, das die im 90°-Winkel verlegten Fliesen perfekt verbindet. „modulo 1“ **(B)** kann auch verwendet werden, direkt auf der Ecke der zu bekleidenden Säule platziert. (Wir empfehlen, die Fugen zwischen „modulo 1“ und den daneben verlegten Fliesen zu verfüllen)

Для покрытия внешнего угла можно использовать специальную деталь «quartino» **(A)**, которая идеально соединяет плитки, установленные под углом 90 градусов. Также можно использовать “modulo 1” **(B)**, размещенный непосредственно на углу облицованной колонны. (Желательно заполнить швы между “modulo 1” и установленной рядом плиткой).

Para revestir una esquina exterior, es posible utilizar la pieza especial “quartino” **(A)**, que conecta perfectamente las baldosas instaladas a 90°. También se puede utilizar el “modulo 1” **(B)**, instalado directamente en la esquina de la columna a revestir. (Aconsejamos rellenar las juntas entre el “modulo 1” y las baldosas instaladas a sus lados).

LAPIS POSA DI UN ANGOLO INTERNO

LAYING ON AN INTERNAL CORNER

A

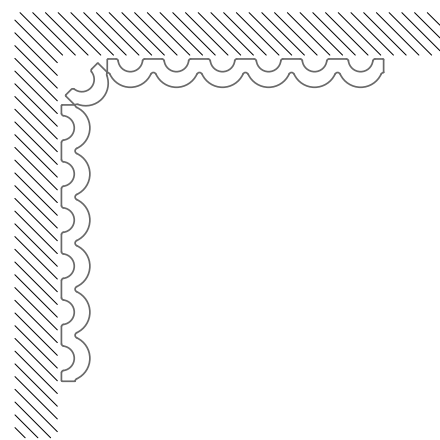

B

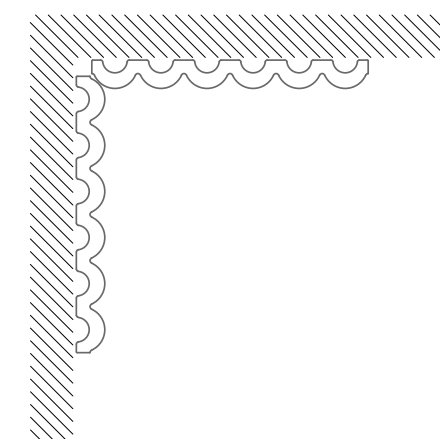

Per rivestire un angolo interno, è possibile utilizzare il “modulo 1” **(A)**, iniziando la posa proprio a partire dall’angolo. In alternativa, si possono far combaciare direttamente i lati delle piastrelle LAPIS di formato 10x30 cm e 30x30 cm **(B)**.

To cover an internal corner, you can use the “modulo 1” **(A)**, starting the laying right from the corner, or you can directly join the edges of the 10x30 cm and the 30x30 cm LAPIS tiles, without using any special piece **(B)**.

Pour revêtir un coin intérieur, il est possible d’utiliser le « modulo 1 » **(A)**, en commençant la pose à partir du coin, ou bien de joindre les carreaux 10x30 cm ou 30x30 cm directement, sans aucune pièce spéciale **(B)**.

Um eine Innenecke zu verkleiden, können Sie „modulo 1“ **(A)** verwenden, indem Sie die Verlegung von der Ecke aus beginnen, oder Sie können auch die Fliesen 10x30 cm oder 30x30 cm verlegen, indem Sie ihre Kanten direkt ohne spezielles Stück verbinden **(B)**.

Чтобы закрыть внутренний угол, вы можете использовать “modulo 1” **(A)**, начиная укладку с угла, или вы также можете установить плитки размером 10x30 см или 30x30 см, соединив их стороны напрямую, без особых элементов **(B)**.

Para cubrir una esquina interior, se puede utilizar el “modulo 1” **(A)**, comenzando la instalación desde la esquina, o también se pueden instalar las baldosas de 10x30 cm o 30x30 cm, uniendo directamente sus lados, sin alguna pieza especial **(B)**.

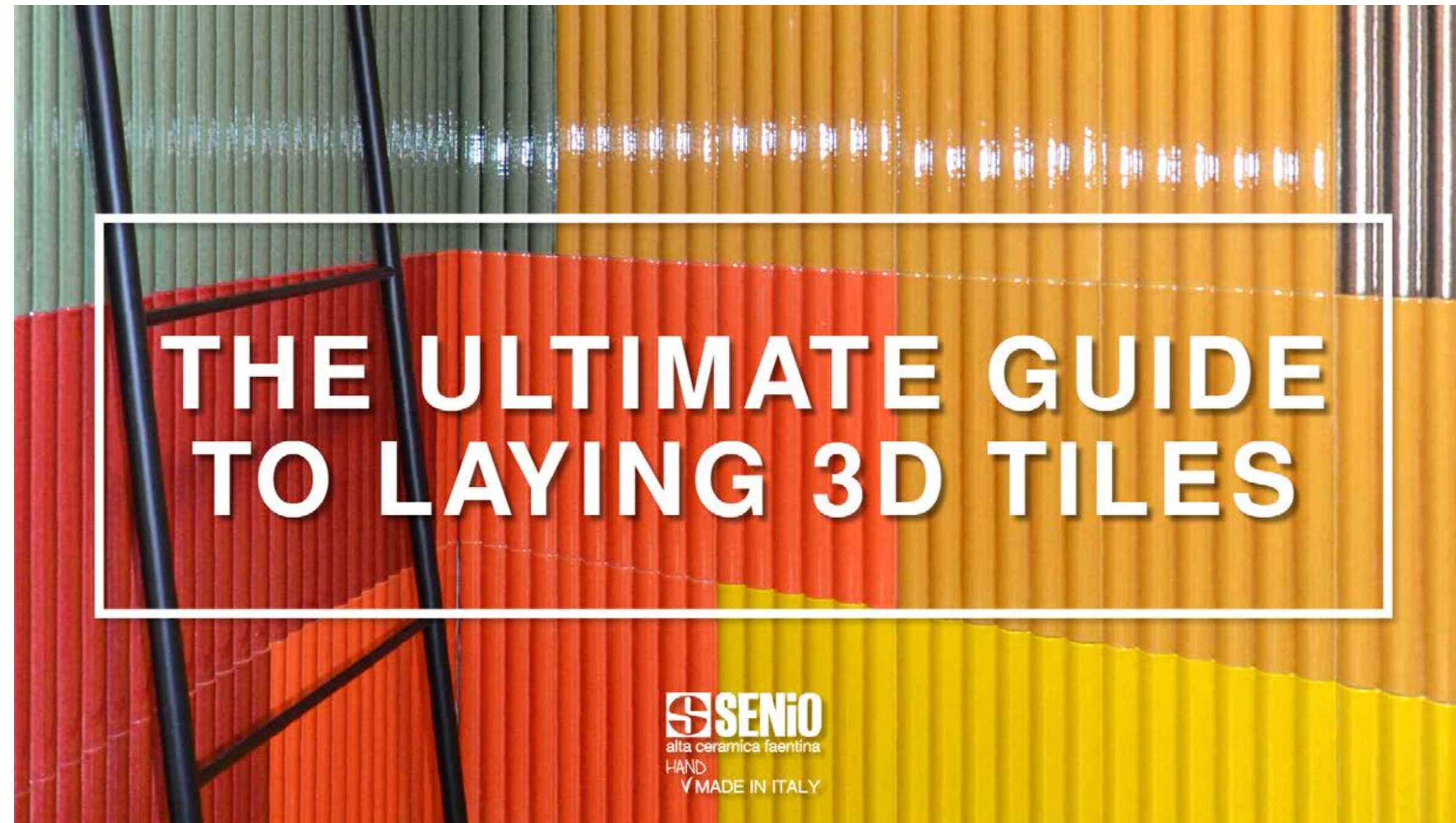

<https://www.youtube.com/watch?v=5RsDCsvExdc>

Lapis si può posare anche su legno compensato utilizzando un collante adatto a queste superfici. Ideale per rivestire banconi da bar e reception.

Lapis can also be laid on wood and plywood, using an adhesive suitable for these surfaces. Ideal for covering bar and reception counters.

Le Lapis peut également être posé sur du bois et du contreplaqué, en utilisant un adhésif approprié pour ces surfaces. Idéal pour revêtir les comptoirs de bar et de réception.

Lapis kann auch auf Holz und Sperrholz mit einem für diese Oberflächen geeigneten Klebstoff verlegt werden. Hervorragend geeignet zum Abdecken von Bar- und Empfangstheken.

Ляпис можно также укладывать на дерево и фанеру с помощью клея, подходящего для этих поверхностей. Отлично подходит для покрытия барных стоек и стоек ресепшн.

Lapis también se puede instalar sobre madera y contrachapado, utilizando un adhesivo adecuado para estas superficies. Ideal para revestir barras de bares y mesas de recepción.

Os azulejos Lapis também podem ser aplicados sobre madeira e contraplacado, utilizando um adesivo adequado para essas superfícies. Ideal para revestir bares e contadores de recepção.

LAPIS

PASSIONE, QUALITÀ E TRADIZIONE, QUESTI SONO I NOSTRI INGREDIENTI.
PASSION, QUALITY AND TRADITION, THESE ARE OUR INGREDIENTS.



La “bicottura” è la ceramica realizzata ancora con polvere di terra, cotta a temperatura superiore a 1000 °c e smaltata con un intervento manuale, per dare al tuo rivestimento quel tocco in più di artigianale e di naturale che altri prodotti non hanno. Questa piastrella, cotta “ben 2 volte”, è la ceramica, in quanto data da terra, smalto e fuoco. Alcune deformazioni, irregolarità, impurità e accumuli di smalto sono da imputarsi all’intervento manuale e quindi da considerarsi un pregio, rendendo ogni pezzo quasi unico. Il risultato finale è un rivestimento dal sapore naturale e originale al tempo stesso.

“Double-firing” is the process that still produces Ceramics made with earth dust, double-fired at more than 1000 °C (1832 °F) and glazed with a manual intervention, to give your wall that special natural touch of craftsmanship that other products do not have. This tile, fired twice, is the real Ceramics, understood as a blending of Earth, Glaze and Fire. Some deformations, irregularities, impurities and accumulations of glaze are due to manual intervention and they are to be considered a value, making each piece almost unique. The result is a covering with a natural and original flavour at the same time.

COTTO NATURALE

Superficie opaca e porosa, detta anche “biscotto”, tipica della ceramica dopo la prima cottura.

Matt and porous surface, also called “biscuit”, typical of ceramics after the first firing.

Surface opaque et poreuse, aussi appelée “biscuit”, typique des céramiques après la première cuisson.

Opake und poröse Oberfläche, auch “Keks” genannt, typisch für Keramik nach dem ersten Brand.

Непрозрачная и пористая поверхность, также называемая «бисквитной», характерна для керамики после первого обжига.

Superficie opaca y porosa, también llamada “bizcocho”, típica de la cerámica después de la primera cocción.

COTTO CERATO

Superficie opaca e porosa detta anche “biscotto” tipica della ceramica dopo la prima cottura., su cui è applicato un film di cera che rende il colore originale più intenso e tendente al rossiccio. Questa finitura è solo a fine estetico e non ne altera le caratteristiche del prodotto il quale rimane poroso come il manufatto non cerato.

Matt and porous surface, also called “biscuit”, typical of ceramics after the first firing, on which a layer of wax is applied which makes the original color more intense and tending to reddish. This finish is for aesthetic purposes only and does not alter the characteristics of the product which remains as porous as the unwaxed product.

Surface opaque et poreuse, aussi appelée “biscuit”, typique des céramiques après la première cuisson, sur laquelle est appliquée une couche de cire qui rend la couleur d’origine plus intense et tendant au rouge. Cette finition n’a qu’un but esthétique et n’altère pas les caractéristiques du produit qui reste aussi poreux que le produit non ciré.

Opake und poröse Oberfläche, auch “Biskuit” genannt, typisch für Keramik nach dem ersten Brand, auf die eine Wachsschicht aufgetragen wird, die die ursprüngliche Farbe intensiver und zum Rotstich neigend macht. Dieses Finish dient ausschließlich ästhetischen Zwecken und verändert nicht die Eigenschaften des Produkts, das so porös bleibt wie das ungewachste Produkt.

Непрозрачная и пористая поверхность, также называемая «бисквитной», типичная для керамики после первого обжига, на которую наносится слой воска, который делает первоначальный цвет более интенсивным и имеет тенденцию к красноватому оттенку. Эта отделка предназначена только для эстетических целей и не меняет характеристик продукта, который остается таким же пористым, как невощенный продукт.

Superficie opaca y porosa, también llamada “bizcocho”, típica de la cerámica tras la primera cocción, sobre la que se aplica una capa de cera que hace que el color original sea más intenso y con tendencia al rojizo. Este acabado es solo para fines estéticos y no altera las características del producto que permanece tan poroso como el producto sin encerar.

SILK

E’ un effetto superficiale dello smalto opaco, leggermente satinato e morbido al tatto come una “seta”.

It’s an effect of the matt glazed finish, that gives the surface a soft silk touch.

C’est un effet de la finition émaillée mate, qui donne à la surface un toucher soyeux et doux.

Es ist ein Effekt der matt glasierten Oberfläche, die eine weiche und seidige Note verleiht.

Эффект матовой глазури, которая придает поверхности мягкость и шелковистость.

Es un efecto del acabado esmaltado mate, que le da a la superficie un toque suave y sedoso.

LACCATO

Superficie lucida quasi specchiante perfettamente liscia e uniforme in tutta la piastrella.

Almost mirror-like glossy surface, perfectly smooth and uniform throughout the tile.

Surface brillante presque semblable à un miroir, parfaitement lisse et uniforme sur tout le carreau.

Fast spiegelglatte Oberfläche, perfekt glatt und gleichmäßig über die gesamte Fliese.

Практически зеркальная глянцевая поверхность, идеально гладкая и однородная по всей плитке.

Superficie brillante casi como un espejo, perfectamente lisa y uniforme en toda la baldosa.

BIANCO MAIOLICA

Smalto con superficie bianca, craquelé, lucida, con crepe nere, matt. Questa finitura ricorda la tradizionale maiolica di Faenza usata nell'oggettistica e richiama quindi un piacevole stile retrò.

This finish of the traditional Faenza majolica, used to produce various ceramic objects, so it recalls a nice retro style.

Finition de surface brillante, craquelée, blanche, avec craquelure noire, matte. Cet émail rappelle la majolique traditionnelle de Faenza, utilisée pour produire plusieurs objets en céramique. Elle donne donc une saveur rétro très agréable.

Weißes craquelé glänzendes Oberflächenfinish mit mattschwarzem Krepp. Dieses Finish erinnert an die traditionelle Faenza Majolika, die zur Herstellung verschiedener Keramikgegenstände verwendet wird, und verleiht so einen Retro-Stil.

Эмаль стекловидная с блестящей потрескивающейся поверхностью, белая с матово-черными трещинами. Эта отделка напоминает традиционную майолику Фазнца, которая используется для изготовления различных керамических изделий, поэтому придает ей ретро-отенок.

Esmalte con superficie blanca, craquelada, brillante, con grietas negras, mate. Este acabado recuerda la mayólica tradicional de Faenza, utilizada para producir varios objetos cerámicos, así que da un sabor retro hermoso.

CRAQUELÉ

E' un particolare effetto superficiale dello smalto, caratterizzato da piccole crepe che sono state provocate dalla differenza dei coefficienti di raffreddamento del supporto e dello smalto. Questo tipo di effetto ceramico è unico e sempre diverso da piastrella a piastrella in quanto la "ragnatela" di crepe si sviluppa in modo incontrollabile.

It's a particular effect of the superficial glaze, characterized by small cracks that have been caused by the difference of cooling support coefficients and of the glaze. This kind of ceramic effect is unique and always different from tile to tile, the "net of cracks" develops uncontrollably.

C'est un effet particulier de l'émail superficiel, caractérisé par de petites fissures qui ont été provoquées par la différence de coefficients de refroidissement du biscuit et de l'émail même. Ce type d'effet céramique est unique et toujours différent d'un carreau à l'autre, car le « filet de fissures » se développe de manière incontrôlable.

Dies ist ein besonderer Effekt der oberflächlichen Glasur, die durch kleine Risse gekennzeichnet ist, die durch die unterschiedlichen Koeffizienten beim Abkühlen von Biskuit und Glasur hervorgerufen wurden. Dieser keramische Effekt ist einzigartig und von Fliese zu Fliese immer unterschiedlich, denn das "Rissennetz" entwickelt sich unkontrolliert.

Это особый эффект поверхностной глазури, характеризующийся небольшими трещинами, вызванными разницей коэффициентов охлаждения бисквита и глазури. Этот вид керамики уникален и всегда отличается от плитки к плитке, потому что «сетка трещин» развивается бесконтрольно.

Es un efecto particular del esmalte superficial, caracterizado por pequeñas grietas que han sido provocadas por la diferencia de coeficientes de enfriamiento del bizcocho y del esmalte. Este tipo de efecto cerámico es único y siempre diferente de una baldosa a otra, porque la "red de grietas" se desarrolla incontrolablemente.

ARGENTO SIDERALE

Superficie metallizzata di colore argento simile al tono “canna di fucile”, caratterizzata dall’essere leggermente opaca, non riflettente.

Metallic silver-coloured surface similar to the “gunmetal” tone, characterized by being slightly matt, non-reflective.

Surface métallique de couleur argentée similaire au ton «gunmetal», caractérisée par être légèrement opaque, non réfléchissante.

Metallische Oberfläche in silberner Farbe ähnlich dem “Gunmetal”-Ton, dadurch gekennzeichnet, dass sie leicht undurchsichtig ist, nicht reflektierend.

Металлическая поверхность серебристого цвета, похожая на «бронзовый» оттенок, отличается легкой непрозрачностью и отсутствием отражения.

Superficie metálica en color plateado similar al tono “gunmetal”, caracterizada por ser ligeramente opaca, no reflectante.

BRUNO DORATO

Superficie metallizzata di colore oro brunito, la cui caratteristica è avere una texture formata da un reticolo di venature tono su tono.

Metallized surface in a burnished gold colour whose characteristic is to have a texture formed by a grid of tone-on-tone veins.

Surface métallisée de couleur or bruni dont la caractéristique est d’avoir une texture formée par une grille de veines ton sur ton.

Metallisierte Oberfläche in brüniertes Goldfarbe, deren Charakteristik eine Textur ist, die durch ein Raster von Ton-in-Ton-Änderungen gebildet wird.

Металлизованная поверхность цвета вороненого золота с текстурой, образованной сеткой прожилок тон в тон.

Acabado metalizado en color oro bruñido cuya característica es tener una textura formada por una rejilla de vetas tono sobre tono.

NERO LUSTRATO MADREPERLA

Superficie preziosa madreperla su base nera laccata. Lo smalto madreperlato è applicato in 3° cottura e conferisce cangianza, metamerismo e riflessione, donando particolari e unici effetti cromatici. Questo smalto racchiude in sé tutti i colori dell’arcobaleno che si esaltano rifrangendo la luce.

Precious mother-of-pearl surface on a black glossy base. The mother of pearl glaze is applied in 3rd firing and gives iridescence, metamerism and reflection, giving particular and unique chromatic effects. This glaze contains all the colours of the rainbow that are enhanced by refracting the light.

Surface en nacre précieuse sur fond noir brillant. L’émail nacré est appliqué en 3ème cuisson et donne irisation, métamérisme et reflet, donnant des effets chromatiques particuliers et uniques. Cet émail contient toutes les couleurs de l’arc-en-ciel qui sont rehaussées par la réfraction de la lumière.

Edle Perlmutteroberfläche auf schwarz glänzendem Untergrund. Die Perlmutterglasur wird im 3. Brand aufgetragen und verleiht Schillern, Metamerie und Reflexion, wodurch besondere und einzigartige Farbeffekte erzielt werden. Diese Glasur enthält alle Farben des Regenbogens, die durch die Lichtbrechung verstärkt werden.

Драгоценная перламутровая поверхность на черной глянцевой основе. Перламутровая глазурь наносится при 3-м обжиге и придает радужность, метамерию и отражение, создавая особые и уникальные хроматические эффекты. Эта глазурь содержит все цвета радуги, которые усиливаются за счет преломления света.

Preciosa superficie de nácar sobre una base negra brillante. El esmalte de nácar se aplica en 3ª cocción y aporta iridiscencia, metamerismo y reflejo, dando efectos cromáticos particulares y únicos. Este esmalte contiene todos los colores del arco iris que se realzan al refractar la luz.

TECHNICAL FEATURES

CARATTERISTICHE TECNICHE

CARATTERISTICHE TECNICHE TECHNICAL FEATURES

TERRACOTTA SMALTATA - GLAZED TERRACOTTA

CLASSIFICAZIONE

UNI EN 14411
STANDARD VALUES
UNI EN 14411

GRUPPO B III - GROUP B III. GL
(Appendice L EN 14411)

METODO DI FORMATURA
PRESSATO A SECCO - DRY PRESSED

	metodo di prova - standard	SUPERFICIE SILK SILK SURFACE valore - value	SUPERFICIE CRAQUELÉ CRAQUELÉ SURFACE valore - value	SUPERFICIE LACCATA GLOSSY SURFACE valore - value	SUPERFICIE MADREPERLA MADREPERLA SURFACE valore - value
ASSORBIMENTO D'ACQUA WATER ABSORPTION	ISO 10545-3	>10 %	>10 %	>10 %	>10 %
RESISTENZA ALLE MACCHIE STAIN RESISTANCE	ISO 10545-14	classe 4 - class 4	classe 1 - class 1	5	classe 1 - class 1
RESISTENZA AL CAVILLO CRAZE RESISTANCE	ISO 10545-11	RESISTE - RESISTANT	non applicabile (effetto decorativo) not applicable (decorative element)	RESISTE - RESISTANT	non applicabile (effetto decorativo) not applicable (decorative element)
RESISTENZA CHIMICA CHEMICAL RESISTANCE	ISO 10545-13	classe GLB - class GLB	classe GLC - class GLC	GA	classe GLC - class GLC



GRANITI VICENTIA

GROUP