

# **BOOST STONE**

PORCELAIN TILE



GRANITI VICENTIA  
GROUP

STONE LOOK

**PORCELAIN TILES**  
**GRES PORCELLANATO**  
Grès cérame  
Feinsteinzeug  
Gres porcelánico  
Керамический гранит



INDEX



OVERVIEW



IMAGE GALLERY



PRODUCT RANGE & TECHNICAL SPECS.



BOOST WORLD



SUSTAINABILITY



THE BENEFITS OF CERAMIC TILES





©

Index

INDEX



Overview

OVERVIEW



Image Gallery

IMAGE  
GALLERY



Product Range &  
Technical Specs

SENSITECH  
RANGE SUMMARY  
TECHNICAL FEATURES

PRODUCT  
RANGE &  
TECHNICAL  
SPECS.



Boost World

BOOST WORLD



Sustainability

SUSTAINABILITY



The benefits of Ceramic Tiles

THE BENEFITS OF  
CERAMIC TILES





# Porcelain tiles: a safe choice.

**RECYCLABLE**  
Riciclabile

**SAFE**  
Sicuro

**ECO-FRIENDLY**  
Ama l'ambiente

**VERSATILE**  
Versatile

**FIREPROOF**  
Non brucia

**HYGIENIC**  
Igienico

**LONG LASTING**  
Dura a lungo

**RESISTANT**  
Resistente

**EASY TO CLEAN  
AND DISINFECT**  
Facile da pulire e sanificare

**ZERO PVC**  
Zero PVC



page 110

INDEX



OVERVIEW



IMAGE  
GALLERY



PRODUCT  
RANGE &  
TECHNICAL  
SPECS.



BOOST WORLD



SUSTAINABILITY



THE BENEFITS OF  
CERAMIC TILES



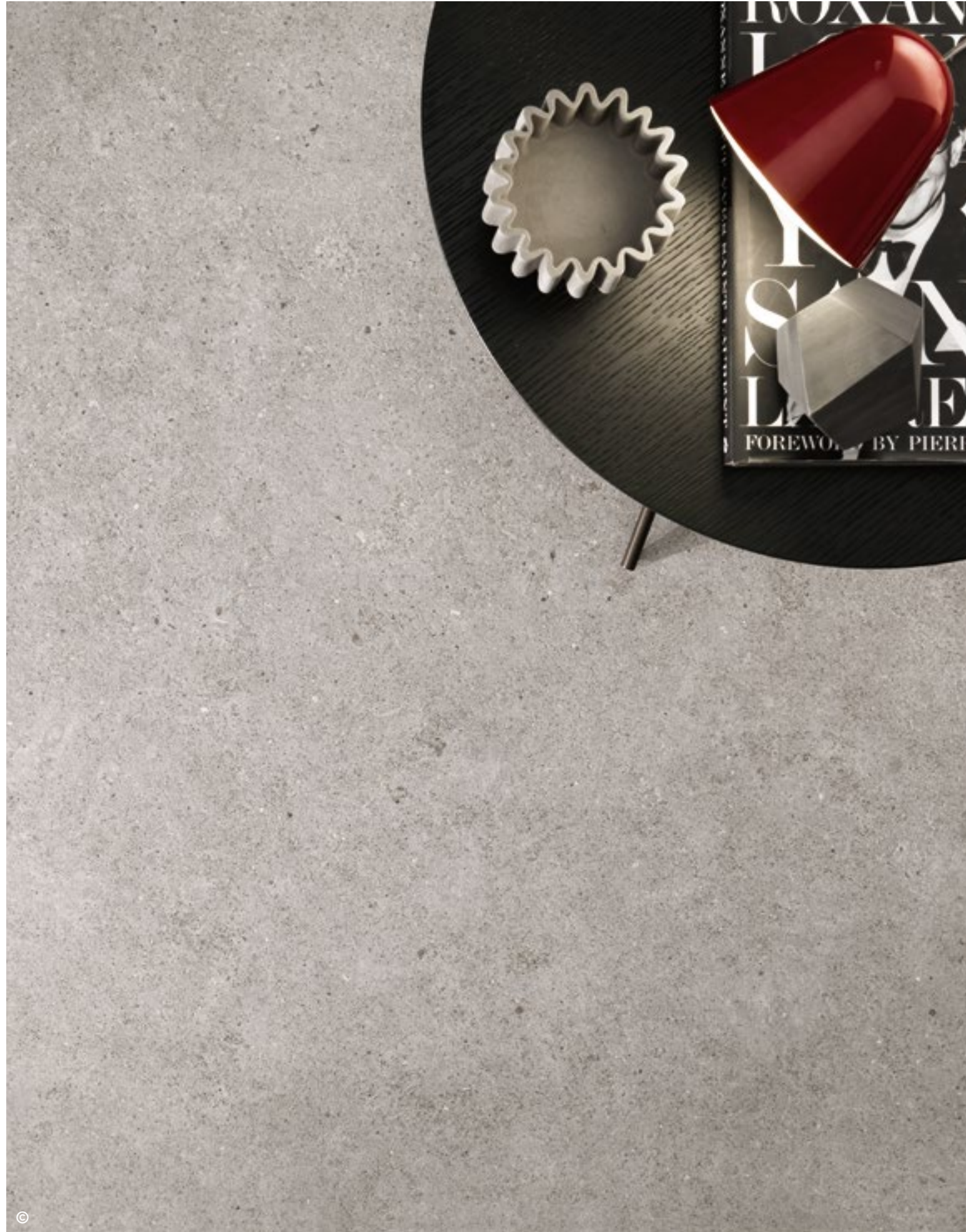

# The Stone Appeal.

Boost Stone is the collection of porcelain floor and wall tiles conceived to offer the world of design a modern stone effect. Inspired by the limestone rocks extracted from the quarries of the Pyrenees and produced in a range of neutral tones, it allows you to create environments with a strong contemporary accent.

Boost Stone è la collezione di pavimenti e rivestimenti in gres porcellanato pensata per offrire al mondo della progettazione un moderno effetto pietra. Ispirata alle rocce calcaree estratte dalle cave dei Pirenei e declinata in un ventaglio cromatico di tonalità neutre, permette di creare ambienti dal forte accento contemporaneo.

Boost Stone est la collection de sols et de revêtements muraux en grès cérame conçue pour offrir au monde du design un effet pierre moderne. Inspiré des roches calcaires extraites des carrières des Pyrénées et déclinée dans une gamme chromatique de nuances neutres, elle permet de créer des ambiances à fort accent contemporain.

Boost Stone ist eine Kollektion aus Feinsteinzeugbelägen für Wand und Boden, die dem Planer eine moderne Steinoptik bietet. Sie ist an den Kalkfelsen pyrenäischer Steinbrüche inspiriert und in einer ganzen Palette aus neutralen Farben erhältlich, um Räume mit einem klar kontemporenen Akzent zu gestalten.

Boost Stone es una colección de pavimentos y revestimientos de gres porcelánico creada para ofrecer al mundo del diseño un moderno efecto piedra. Inspirada en las piedras calizas extraídas de las canteras de los Pirineos y disponible en una gama de tonos neutros, permite crear ambientes con un fuerte acento contemporáneo.

Boost Stone – это коллекция керамогранита и настенной плитки, задуманная, чтобы предложить миру дизайна современный эффект камня для стильного и современного оформления пространств. У ее истоков – известняк, добываемый в каменоломнях Пиренеев.

INDEX



OVERVIEW



IMAGE GALLERY



PRODUCT RANGE & TECHNICAL SPECS.



BOOST WORLD



SUSTAINABILITY



THE BENEFITS OF CERAMIC TILES



# Architectural instinct.

Stone-effect surfaces offer architects and designers an infinite number of combinations and total design freedom. With their simple look, they allow floors and walls of residential, commercial, and hospitality spaces to be decorated with a stylistic harmony.

Le superfici effetto pietra consentono ad architetti e designer infinite possibilità di abbinamento e una totale libertà progettuale. Con il loro look essenziale, permettono di rivestire con un'armonia stilistica pavimenti e pareti di spazi residenziali, commerciali e dell'ospitalità.

Les surfaces effet pierre permettent aux architectes et aux concepteurs des possibilités de combinaison infinies et une liberté de conception totale. Avec leur aspect essentiel, elles permettent de couvrir les sols et les murs des espaces résidentiels, commerciaux et d'accueil avec une harmonie stylistique.

Die Beläge in Steinoptik bieten Architekten und Designern unendliche Kombinationsmöglichkeiten und absolute planerische Freiheit. Mit ihrem schlichten Look erlauben sie, Wände und Böden in Wohn- und Gewerberäumen sowie im Gastgewerbe mit stilistischer Harmonie zu verkleiden.

Las superficies de efecto piedra permiten a los arquitectos y diseñadores un sinfín de posibilidades de combinación y una total libertad de diseño. Con su aspecto esencial, permiten revestir suelos y paredes de espacios residenciales, comerciales y hoteleros con armonía y estilo.

Плитка под камень предоставляет архитекторам и дизайнерам бесчисленные возможности сочетания для реализации любых замыслов. Благодаря своему лаконичному виду она способна стильно и гармонично украсить полы и стены домашних пространств, магазинов, отелей, ресторанов.



INDEX



OVERVIEW



IMAGE GALLERY



PRODUCT RANGE & TECHNICAL SPECS.



BOOST WORLD



SUSTAINABILITY



THE BENEFITS OF CERAMIC TILES





# More than real.

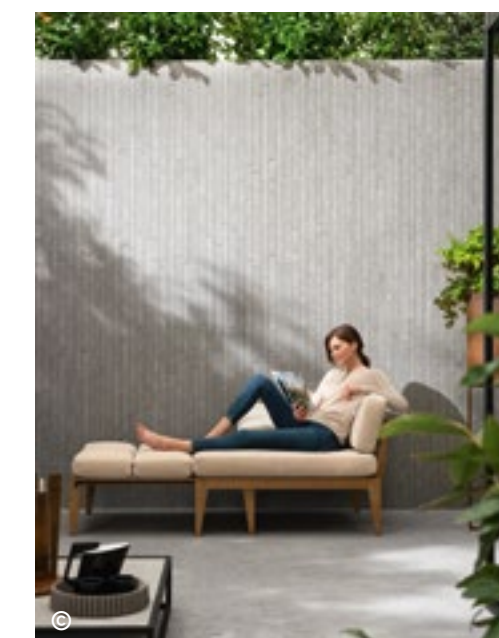

The compact background creates a uniform view with discreet tones, delicate colors, and minimal shading. Upon closer inspection, the texture is enriched with details that reproduce the original stone with extreme realism.

Il fondo compatto restituisce una visione d'insieme omogenea, con toni discreti, cromie delicate e stonalizzazioni minime. A una visione ravvicinata, la texture si arricchisce invece di dettagli riprodotti con estremo realismo che riproducono alla perfezione la superficie variegata della pietra di ispirazione.

Le fond compact donne une vue d'ensemble homogène, avec des tons discrets, des couleurs délicates et un effet dénuancé minimal. À y regarder de plus près, la texture s'enrichit de détails qui reproduisent la pierre d'inspiration avec un réalisme extrême.

Der kompakte Untergrund wird als einheitliche Oberfläche wahrgenommen, mit verhaltenen Nuancen, zarten Farben und minimalen Farbabweichungen. Aus der Nähe betrachtet bereichert sich die Textur hingegen um Details, die den als Vorbild dienenden Stein mit extremem Realismus wiedergeben.

El fondo compacto ofrece una visión de conjunto homogénea, con tonos discretos, colores delicados y contrastes mínimos. Si se observa con detenimiento, la textura se enriquece con detalles que reproducen la piedra fuente de inspiración con un realismo extremo.

Плотную поверхность плитки характеризуют неброская окраска и легкий разнотон, но в целом она дарит ощущение приятной однородности. При рассмотрении с близкого расстояния можно разглядеть детали, которые с предельным реализмом отражают рисунок исходного образца камня.

INDEX



OVERVIEW



IMAGE GALLERY



PRODUCT RANGE & TECHNICAL SPECS.



BOOST WORLD



SUSTAINABILITY



THE BENEFITS OF CERAMIC TILES



# A dialog between surfaces.

Boost Stone interprets the timeless personality of stone with a palette of ten neutral colors from the concrete-effect world of the Boost and Boost Pro collections. These shades range from light to dark, both in cool and warm colors.

Boost Stone interpreta la personalità senza tempo della pietra con una palette di dieci colori neutri provenienti dal mondo dell'effetto cemento delle collezioni Boost e Boost Pro. Queste tonalità si estendono dalle nuance più chiare a quelle più scure, sia nelle cromie fredde che calde.

Boost Stone interprète la personnalité intemporelle de la pierre avec une palette de dix couleurs neutres issues de l'univers de l'effet béton des collections Boost et Boost Pro. Ces nuances vont des plus claires aux plus foncées, aussi bien dans les couleurs froides que chaudes.

Boost Stone interpretiert die zeitlose Persönlichkeit des Steins mit einer Palette aus zehn neutralen Farben aus der Welt der Zementoptik der Kollektionen Boost und Boost Pro. Diese Farbtöne reichen von helleren bis zu dunkleren Nuancen, in kalten als auch in warmen Farbvarianten.

Boost Stone interpreta la personalidad atemporal de la piedra con una paleta de diez colores neutros del mundo del cemento de las colecciones Boost y Boost Pro. Estas tonalidades van desde los matices más claros a los más oscuros, tanto en colores fríos como cálidos.

Boost Stone интерпретирует вневременную красоту камня в палитре из десяти нейтральных тонов, перенятых у коллекций под цемент Boost и Boost Pro. Палитра охватывает тона от светлых до более темных, как холодных, так и теплых оттенков.

## BOOST STONE



## BOOST



## BOOST PRO



INDEX



OVERVIEW



IMAGE GALLERY



PRODUCT RANGE & TECHNICAL SPECS.



BOOST WORLD



SUSTAINABILITY



THE BENEFITS OF CERAMIC TILES





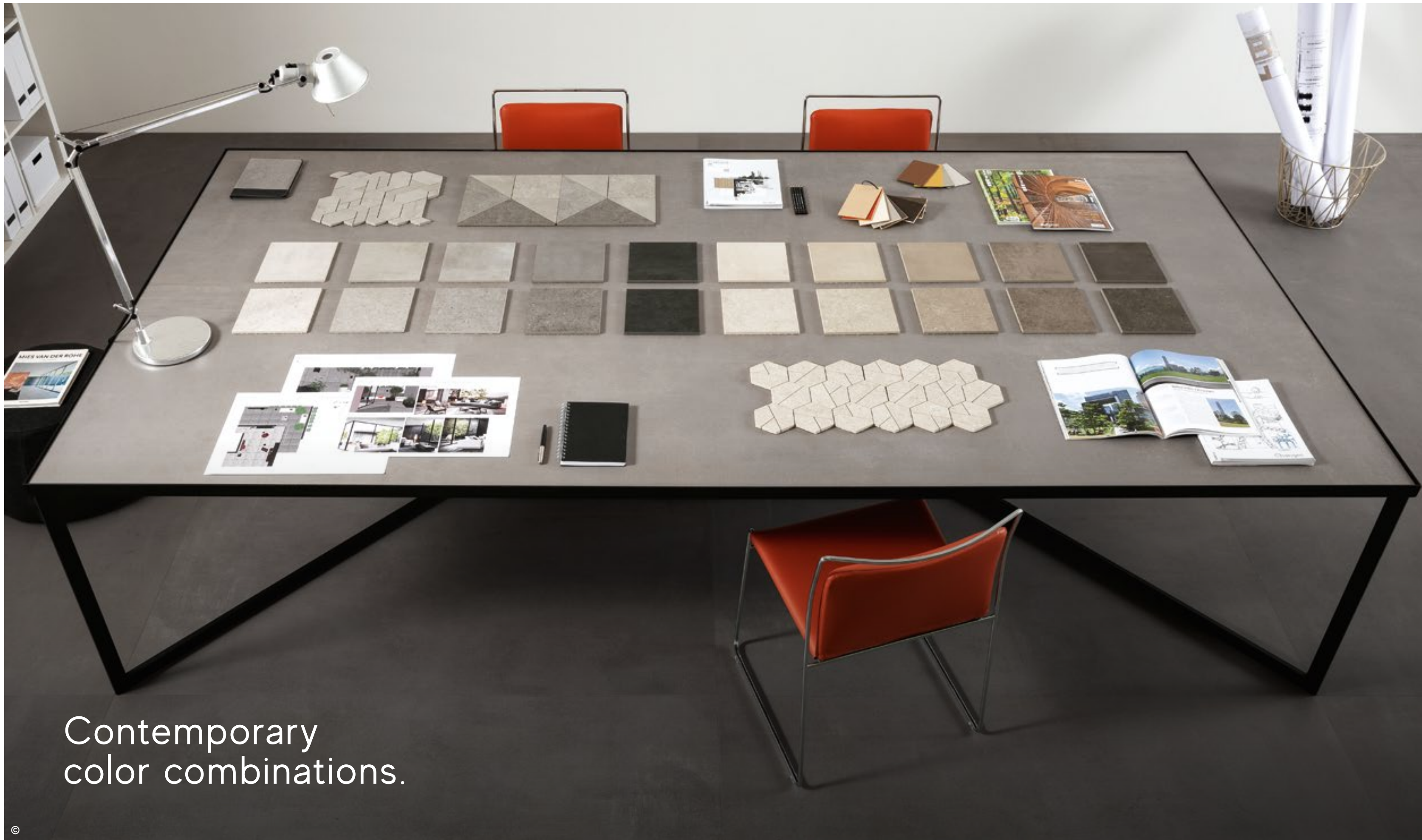

Contemporary  
color combinations.

INDEX



OVERVIEW



IMAGE  
GALLERY



PRODUCT  
RANGE &  
TECHNICAL  
SPECS.



BOOST WORLD



SUSTAINABILITY



THE BENEFITS OF  
CERAMIC TILES





**120x278cm**  
 ± 6mm  
 Available in all colors

# Broad Horizons.

The 120x278 size, ideal for expanding the perception of space, can be used to cover walls, exterior facades, and furnishing elements, ensuring greater visual uniformity. Available in ten colors, it offers one of the widest ranges of large-format stone-effect surfaces.

Il formato 120x278, ideale per ampliare la percezione degli spazi, può essere utilizzato per rivestire pareti, facciate esterne ed elementi d'arredo, garantendo una maggiore omogeneità visiva. Disponibile in dieci colorazioni, offre una delle più vaste gamme di superfici effetto pietra in grande formato.

Le format 120x278, idéal pour élargir la perception des espaces, peut être utilisé pour couvrir les murs, les façades extérieures et les éléments d'ameublement, assurant une plus grande homogénéité visuelle. Décliné en dix coloris, il propose l'une des plus larges gammes de surfaces effet pierre grand format.

Das zur optischen Vergrößerung der Räume ideale Format 120x278 kann zur Verkleidung von Wänden, Außenfassaden und Einrichtungselementen verwendet werden, um eine größere optische Einheitlichkeit zu gewährleisten. Die zehn Farbvarianten bilden eines der umfassendsten Steinoptik-Sortimente in Großformat.

El tamaño 120x278, ideal para ampliar la percepción de los espacios, puede utilizarse para revestir paredes, fachadas exteriores y elementos de mobiliario, garantizando una mayor uniformidad visual. Está disponible en diez colores y ofrece una de las más amplias gamas de superficies de gran tamaño con efecto piedra.

Формат 120x278 визуально делает пространства больше и подходит для облицовки стен, наружных фасадов, предметов интерьера, позволяя придать обстановке эффектную цельность. Доступен в десяти цветах, и эта палитра – одна из самых богатых в том, что касается крупноформатных плит под камень.

INDEX 

OVERVIEW 

IMAGE GALLERY 

PRODUCT RANGE & TECHNICAL SPECS. 

BOOST WORLD 

SUSTAINABILITY 

THE BENEFITS OF CERAMIC TILES 



# The dimensions of design.

## Porcelain Tiles for Floors and Walls

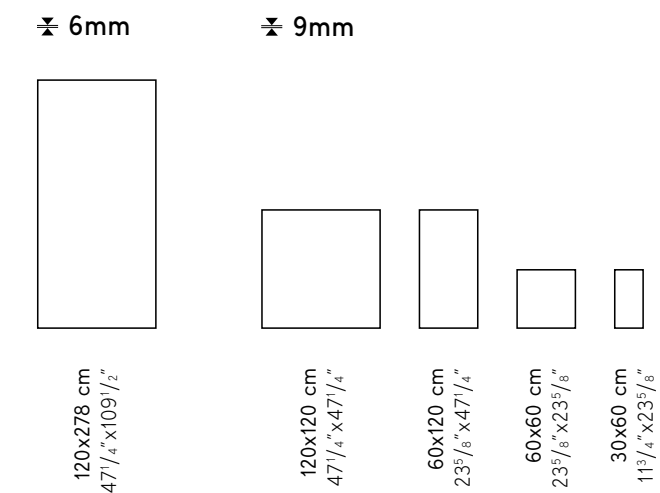

The wide range allows you to design with creativity in every environment, presenting numerous combinations, mixes of colors, and modular formats. The sculpted power of stone is combined with colors, finishes, and decors designed to dialog with the concrete effect of the Boost collections.

L'ampia gamma permette di progettare con creatività in ogni ambiente, presentando numerose combinazioni, intrecci di colori e formati modulari. La forza scultorea della pietra si associa a cromie, finiture e decori progettati per dialogare con l'effetto cemento delle collezioni del mondo Boost.

La large gamme vous permet de concevoir avec créativité dans n'importe quel environnement, en présentant de nombreuses combinaisons, entrelacements de couleurs et formats modulaires. La force sculpturale de la pierre s'allie à des couleurs, des finitions et des décors conçus pour dialoguer avec l'effet béton des collections de l'univers Boost.

Die umfassende Produktpalette erlaubt die kreative Planung jedes Raums mit zahlreichen Kombinationen aus Farben und Formaten. Zur bildhauerischen Kraft des Steins kommen die Farben, Oberflächen und Dekore, die eigens darauf ausgelegt sind, mit der Zementoptik der Kollektionen aus der Welt von Boost kombiniert zu werden.

La amplia gama permite diseñar de forma creativa cualquier ambiente con diferentes combinaciones, tramas de colores y formatos modulares. La fuerza escultórica de la piedra se combina con colores, acabados y decoraciones diseñados para dialogar con el efecto cemento de las colecciones del mundo Boost.

Широкая гамма дает возможность креативно оформлять любое пространство посредством многочисленных комбинаций цветов и модульных форматов. Скульптурная выразительность камня проявляется в большом разнообразии тонов, поверхностных отделок, декоративных элементов и прекрасно сочетается с эффектом цемента коллекций Boost.

INDEX



OVERVIEW



IMAGE GALLERY



PRODUCT RANGE & TECHNICAL SPECS.



BOOST WORLD



SUSTAINABILITY



THE BENEFITS OF CERAMIC TILES



# Life in the open air.

## Porcelain Tiles for Outdoor and Wet Areas

± 9mm GRIP

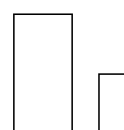

60x120 cm  
23<sup>5</sup>/<sub>8</sub>"x47<sup>1</sup>/<sub>4</sub>"  
30x60 cm  
11<sup>3</sup>/<sub>4</sub>"x23<sup>5</sup>/<sub>8</sub>"

± 20mm OUTDOOR

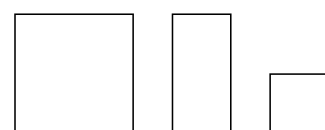

120x120 cm  
47<sup>1</sup>/<sub>4</sub>"x47<sup>1</sup>/<sub>4</sub>"  
60x120 cm  
23<sup>5</sup>/<sub>8</sub>"x47<sup>1</sup>/<sub>4</sub>"  
60x60 cm  
23<sup>5</sup>/<sub>8</sub>"x23<sup>5</sup>/<sub>8</sub>"

Boost Stone offers a selection of dedicated finishes and increased thicknesses for the design of outdoor spaces that are capable of blending harmoniously into the surrounding natural environment. The various sizes in 9 mm Grip and 20 mm ensure stylistic continuity between the indoors and outdoors, combining a high quality look with superior performance.

Boost Stone propone una selezione di finiture dedicate e spessori maggiorati per la progettazione di spazi outdoor, capaci di integrarsi armonicamente con l'ambiente naturale circostante. I diversi formati in 9 mm Grip e 20 mm assicurano una continuità stilistica tra interno ed esterno, combinando un'estetica di pregio a performance elevate.

Boost Stone propose une sélection de finitions dédiées et d'épaisseurs accrues pour la conception d'espaces extérieurs, capables de s'intégrer harmonieusement dans l'environnement naturel environnant. Les différentes tailles en 9 mm Grip et 20 mm assurent une continuité stylistique entre l'intérieur et l'extérieur, alliant une esthétique de haute qualité à des performances élevées.

Boost Stone bietet eine Reihe spezifischer Oberflächen sowie erhöhte Stärken für die Planung von Außenbereichen, die sich harmonisch in die Landschaft integrieren. Die verschiedenen Formate in 9 mm Grip und 20 mm sorgen für stilistische Kontinuität zwischen Drinnen und Draußen, und sie verbinden eine prestigevolle Optik mit hohen Leistungen.

Boost Stone ofrece una selección de acabados dedicados y espesores aumentados para el diseño de espacios exteriores, de manera tal de que se pueda integrar armoniosamente con el entorno natural que los rodea. Los diferentes tamaños de 9 mm Grip y 20 mm garantizan la continuidad estilística entre el interior y el exterior, combinando una estética fina con un alto rendimiento.

Boost Stone предлагает ряд специальных поверхностных отделок и увеличенных толщин для укладки на улице, что позволяет гармонично вписать плитку в ландшафт. С помощью различных форматов толщиной 9 мм Grip и 20 мм интерьер и улицу можно связать в одно стилистическое целое, дополнив эстетику высокими эксплуатационными показателями.



INDEX



OVERVIEW



IMAGE GALLERY



PRODUCT RANGE & TECHNICAL SPECS.



BOOST WORLD



SUSTAINABILITY



THE BENEFITS OF CERAMIC TILES





A smooth  
and safe effect.

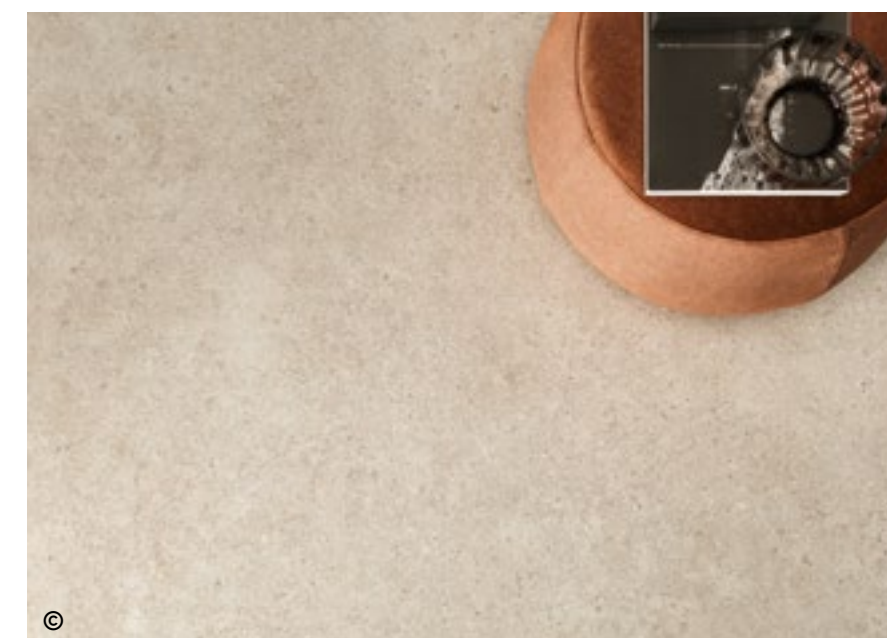
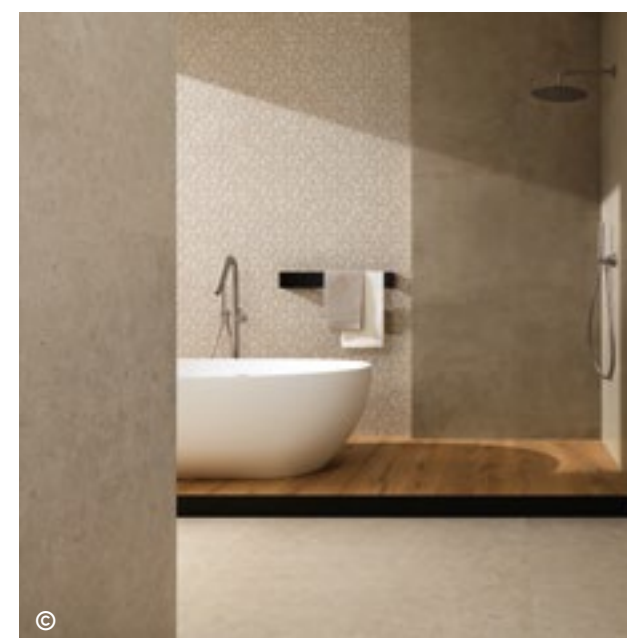

 **Sensitech** SAFE. SOFT. SMART.

INDEX



OVERVIEW



IMAGE GALLERY



PRODUCT RANGE & TECHNICAL SPECS.



BOOST WORLD



SUSTAINABILITY



THE BENEFITS OF CERAMIC TILES



# A world of design.



DOWNLOAD THE CATALOG



With Boost World it's possible to combine different surfaces with a similar stylistic perspective. Concrete, stone, and raw earth effects can be combined spontaneously and naturally to create original harmonies, for cohesive environments that are able to speak the same language.

Con Boost World è possibile combinare superfici diverse in una medesima prospettiva stilistica. Effetto cemento, pietra e terra cruda si combinano in armonie cromatiche inedite in modo spontaneo e naturale, per ambienti coesi e in grado parlare lo stesso linguaggio.

Avec Boost World, il est possible de combiner différentes surfaces dans la même perspective stylistique. Effet béton, pierre et terre crue se combinent dans des harmonies chromatiques inédites de manière spontanée et naturelle, pour des environnements cohérents capables de parler le même langage.

Mit Boost World lassen sich unterschiedliche Oberflächen in ein und derselben stilistischen Perspektive zusammenstellen. Die Optik von Zement, Stein und ungebranntem Ton fließt spontan und natürlich in neue, farblich harmonische Kompositionen ein. Daraus entstehen klar durchgestylte Bereiche, die eine gemeinsame Sprache sprechen.

Con Boost World es posible combinar diferentes superficies en una misma perspectiva estilística. Efecto hormigón, piedra y tierra cruda se combinan en nuevas armonías cromáticas de forma espontánea y natural, para lograr entornos cohesionados que hablan el mismo idioma.

Разные поверхности Boost World сосуществуют в единой стилистической перспективе. Имитации цемента, камня, сырой глины вместе создают необыкновенную цветовую гармонию. В украшенных этой плиткой интерьерах все говорит на одном языке.

INDEX



OVERVIEW



IMAGE GALLERY



PRODUCT RANGE & TECHNICAL SPECS.



BOOST WORLD



SUSTAINABILITY



THE BENEFITS OF CERAMIC TILES



# Image Gallery

Private Villa In&Out - Cream, Ivory



Living Room In&Out - Grey



Studio&Terrace - Tarmac



Residential outdoor, kitchen - White



Residential Bathroom - White



Residential Bathroom - Ivory



Wellness Spa&Relax - Taupe, Clay



Commercial Restroom - Smoke



Fashion Showroom - Ivory



OVERVIEW



IMAGE GALLERY



- PRIVATE VILLA IN&OUT - Cream, Ivory
- LIVING ROOM IN&OUT - Grey
- STUDIO&TERRACE - Tarmac
- RESIDENTIAL OUTDOOR, KITCHEN
- RESIDENTIAL BATHROOM - White
- RESIDENTIAL BATHROOM - Ivory
- WELLNESS SPA&RELAX - Taupe, Clay
- COMMERCIAL RESTROOM - Smoke
- FASHION SHOWROOM - Ivory

PRODUCT RANGE & TECHNICAL SPECS.



BOOST WORLD



SUSTAINABILITY



THE BENEFITS OF CERAMIC TILES





# Limitless Design.

The stone effect of Boost Stone finds its maximum expression in the design of outdoor environments. Here its palette of neutral shades is able to interact harmoniously with the colors of the surrounding nature, giving life to projects with a refined elegance.

L'effetto pietra di Boost Stone trova la massima espressione nella progettazione di ambienti esterni. Qui la palette di sfumature neutre è in grado di intrecciarsi armonicamente con i colori della natura circostante, e dare vita a progetti dalla raffinata eleganza.

L'effet pierre de Boost Stone trouve son expression maximale dans la conception d'environnements extérieurs. Ici, la palette de nuances neutres est capable de s'entrelacer harmonieusement avec les couleurs de la nature environnante, et de donner vie à des projets d'une élégance raffinée.

Die Steinoptik von Boost Stone findet ihren höchsten Ausdruck in der Gestaltung von Außenbereichen. Ihre Palette neutraler Farbtöne lässt sich harmonisch in die Farben der umliegenden Natur integrieren, so dass Projekte von ausgesuchter Eleganz entstehen.

El efecto piedra de Boost Stone se expresa mejor en el diseño de exteriores. Aquí, la paleta de tonos neutros se combina armoniosamente con los colores de la naturaleza circundante y crea proyectos de refinada elegancia.

Эффект камня плиток Boost Stone максимально раскрывает свой потенциал в наружных пространствах. Здесь палитра нейтральных тонов гармонично переключается с красками окружающего пейзажа, что рождает изысканную элегантность.

INDEX



OVERVIEW



IMAGE GALLERY



PRIVATE VILLA IN&OUT - Cream, Ivory

LIVING ROOM IN&OUT - Grey

STUDIO&TERRACE - Tarmac

RESIDENTIAL OUTDOOR, KITCHEN

RESIDENTIAL BATHROOM - White

RESIDENTIAL BATHROOM - Ivory

WELLNESS SPA&RELAX - Taupe, Clay

COMMERCIAL RESTROOM - Smoke

FASHION SHOWROOM - Ivory

PRODUCT RANGE & TECHNICAL SPECS.



BOOST WORLD



SUSTAINABILITY



THE BENEFITS OF CERAMIC TILES







Porcelain tile surfaces can cover floors and walls of gardens, terraces, and pool areas. They have a non-slip finish and are resistant to frost, weathering, wear and tear, and foot traffic.

Le superfici in gres porcellanato possono rivestire pavimenti e pareti di giardini, terrazze e aree piscina. Sono dotate di una finitura antiscivolo e resistono a gelo, agenti atmosferici, usura e calpestio.

Les surfaces en grès cérame peuvent recouvrir les sols et les murs des jardins, des terrasses et des piscines. Elles ont une finition antidérapante et résistent au gel, aux agents atmosphériques, à l'usure et à la circulation piétonnière.

Feinsteinzeugbeläge können Böden und Wände von Gärten, Terrassen und Schwimmzonen verkleiden. Sie haben eine rutschfeste Oberfläche und halten Frost, Witterung, Verschleiß und Trittbelastung stand.

Las superficies de gres porcelánico pueden cubrir pavimentos y paredes en jardines, terrazas y zonas de piscina. Tienen un acabado antideslizante y son resistentes a las heladas, los cambios atmosféricos, el desgaste y las pisadas.

Керамогранитной плиткой можно оформлять полы и стены в садах, на террасах, вокруг бассейнов. Она препятствует скольжению и устойчива к морозам, атмосферным воздействиям, износу, пешеходным нагрузкам.



FLOOR  
Boost Stone **Cream** Outdoor ✕  
120x120 cm | 47 1/4" x 47 1/4"

EXTERNAL FACADE  
Boost Stone **Ivory** Matte/Matt

INDEX



OVERVIEW



IMAGE GALLERY



PRIVATE VILLA IN&OUT - Cream, Ivory

LIVING ROOM IN&OUT - Grey

STUDIO&TERRACE - Tarmac

RESIDENTIAL OUTDOOR, KITCHEN

RESIDENTIAL BATHROOM - White

RESIDENTIAL BATHROOM - Ivory

WELLNESS SPA&RELAX - Taupe, Clay

COMMERCIAL RESTROOM - Smoke

FASHION SHOWROOM - Ivory

PRODUCT RANGE & TECHNICAL SPECS.



BOOST WORLD



SUSTAINABILITY



THE BENEFITS OF CERAMIC TILES





©

FLOOR  
 Boost Stone **Tobacco** Matte/Matt  
 120x120 cm | 47/4"x47/4"

INDEX



OVERVIEW



IMAGE GALLERY



PRIVATE VILLA IN&OUT - Cream, Ivory

LIVING ROOM IN&OUT - Grey

STUDIO&TERRACE - Tarmac

RESIDENTIAL OUTDOOR, KITCHEN

RESIDENTIAL BATHROOM - White

RESIDENTIAL BATHROOM - Ivory

WELLNESS SPA&RELAX - Taupe, Clay

COMMERCIAL RESTROOM - Smoke

FASHION SHOWROOM - Ivory

PRODUCT RANGE & TECHNICAL SPECS.



BOOST WORLD



SUSTAINABILITY



THE BENEFITS OF CERAMIC TILES





©

The complete range of finishes and formats allows you to create total-look environments and design coordinated indoor and outdoor spaces having stylistic and visual continuity.

La gamma completa di finiture e formati consente di realizzare ambienti total look, e progettare con una continuità stilistica e visiva spazi interni ed esterni coordinati.

La gamme complète de finitions et de formats permet de créer des ambiances de look total et de concevoir des espaces intérieurs et extérieurs coordonnés avec une continuité stylistique et visuelle.

Das komplette Sortiment aus Oberflächen und Formaten erlaubt die Kreierung eines Total Looks sowie eine stilistische und optische Kontinuität zwischen perfekt aufeinander abgestimmten Innen- und Außenbereichen.

La completa gama de acabados y tamaños permite crear ambientes con un estilo completo y diseñar espacios interiores y exteriores coordinados con continuidad estilística y visual.

Широкая гамма поверхностей и форматов позволяет придавать пространствам цельность и оформлять улицу в гармонии со стилем интерьера.



©

FLOOR  
Boost Stone **Tobacco** Matte/Matt  
120x120 cm | 47 1/4"x47 1/4"

Boost Stone **Cream** Matte/Matt  
120x120 cm | 47 1/4"x47 1/4"

INDEX



OVERVIEW



IMAGE GALLERY



PRIVATE VILLA IN&OUT - Cream, Ivory

LIVING ROOM IN&OUT - Grey

STUDIO&TERRACE - Tarmac

RESIDENTIAL OUTDOOR, KITCHEN

RESIDENTIAL BATHROOM - White

RESIDENTIAL BATHROOM - Ivory

WELLNESS SPA&RELAX - Taupe, Clay

COMMERCIAL RESTROOM - Smoke

FASHION SHOWROOM - Ivory

PRODUCT RANGE & TECHNICAL SPECS.



BOOST WORLD



SUSTAINABILITY



THE BENEFITS OF CERAMIC TILES





INDEX



OVERVIEW



IMAGE GALLERY



PRIVATE VILLA IN&OUT - Cream, Ivory

LIVING ROOM IN&OUT - Grey

STUDIO&TERRACE - Tarmac

RESIDENTIAL OUTDOOR, KITCHEN

RESIDENTIAL BATHROOM - White

RESIDENTIAL BATHROOM - Ivory

WELLNESS SPA&RELAX - Taupe, Clay

COMMERCIAL RESTROOM - Smoke

FASHION SHOWROOM - Ivory

PRODUCT RANGE & TECHNICAL SPECS.



BOOST WORLD



SUSTAINABILITY



THE BENEFITS OF CERAMIC TILES



FLOOR  
Boost Stone **Tobacco** Matte/Matt  
120x120 cm | 47 1/4" x 47 1/4"

Boost Stone **Cream** Matte/Matt  
120x120 cm | 47 1/4" x 47 1/4"

WALL  
Boost Stone **Cream** Matte/Matt  
120x278 cm | 47 1/4" x 109 1/2"

Boost Stone **Tobacco** Matte/Matt  
120x278 cm | 47 1/4" x 109 1/2"



# Authentic space.

For the outdoors, Boost Stone offers a wide range of dedicated surfaces and increased thicknesses. The technical qualities of porcelain tiles ensure durability and high resistance for any application.

Per l'outdoor, Boost Stone propone una vasta offerta di superfici dedicate e spessori maggiorati. Le qualità tecniche del gres porcellanato assicurano durata e resistenza elevata in ogni contesto applicativo.

Pour l'extérieur, Boost Stone propose une large gamme de surfaces dédiées et des épaisseurs accrues. Les qualités techniques du grès cérame garantissent durabilité et haute résistance dans tous les contextes d'application.

Für das Outdoor bietet Boost Stone ein reiches Angebot aus spezifischen Belägen auch in erhöhter Materialstärke. Die technischen Eigenschaften des Feinsteinzeugs garantieren in jedem Anwendungsbereich Langlebigkeit und hohe Beständigkeit.

Para su uso en exteriores, Boost Stone ofrece una amplia gama de superficies dedicadas y de mayor grosor. Las cualidades técnicas del gres porcelánico garantizan la durabilidad y la alta resistencia en cualquier contexto de aplicación.

Для улицы Boost Stone предлагает широкий ассортимент плитки увеличенной толщины. Технические характеристики керамогранита обеспечивают долговечность и стойкость покрытий в любых условиях.

INDEX



OVERVIEW



IMAGE GALLERY



PRIVATE VILLA IN&OUT - Cream, Ivory

LIVING ROOM IN&OUT - Grey

STUDIO&TERRACE - Tarmac

RESIDENTIAL OUTDOOR, KITCHEN

RESIDENTIAL BATHROOM - White

RESIDENTIAL BATHROOM - Ivory

WELLNESS SPA&RELAX - Taupe, Clay

COMMERCIAL RESTROOM - Smoke

FASHION SHOWROOM - Ivory

PRODUCT RANGE & TECHNICAL SPECS.



BOOST WORLD



SUSTAINABILITY



THE BENEFITS OF CERAMIC TILES





FLOOR  
Boost Stone **Grey Grip**  
120x120 cm | 47<sup>1</sup>/<sub>4</sub>"x47<sup>1</sup>/<sub>4</sub>"

OUTDOOR CLADDING  
Boost Stone **Grey Matte/Matt**  
120x120 cm | 47<sup>1</sup>/<sub>4</sub>"x47<sup>1</sup>/<sub>4</sub>"

Boost Stone **Grey Mosaico Brick**  
30x60 cm | 11<sup>3</sup>/<sub>8</sub>"x23<sup>3</sup>/<sub>8</sub>"



INDEX



OVERVIEW



IMAGE GALLERY



PRIVATE VILLA IN&OUT - Cream, Ivory

LIVING ROOM IN&OUT - Grey

STUDIO&TERRACE - Tarmac

RESIDENTIAL OUTDOOR, KITCHEN

RESIDENTIAL BATHROOM - White

RESIDENTIAL BATHROOM - Ivory

WELLNESS SPA&RELAX - Taupe, Clay

COMMERCIAL RESTROOM - Smoke

FASHION SHOWROOM - Ivory

PRODUCT RANGE & TECHNICAL SPECS.



BOOST WORLD



SUSTAINABILITY



THE BENEFITS OF CERAMIC TILES





A practical, versatile decorative element, the Brick mosaic has regular strips of different sizes that can be laid on the wall – both horizontally and vertically – and on the floor.

Élément de décoration pratique et polyvalent, la Mosaïque Brick présente des bandes régulières de différentes tailles qui peuvent être posées au mur, aussi bien horizontalement que verticalement, et au sol.

Elemento decorativo práctico y versátil, el mosaico Brick presenta listones regulares de diferentes tamaños que pueden colocarse en paredes, tanto en horizontal como en vertical, y en pavimentos.

Elemento decorativo pratico e versatile, il Mosaico Brick presenta listelli regolari di diverse dimensioni che può essere posato a parete, sia in orizzontale che in verticale, ed a pavimento.

Das funktionelle und vielseitige Dekorelement Mosaik Brick besteht aus regelmäßigen, aber unterschiedlich großen Leisten. Es kann sowohl waagrecht als auch senkrecht an der Wand und auch am Boden verlegt werden.

Мозаика Brick – практичный и универсальный декоративный элемент. Состоит из ровных планок разных размеров и может быть уложена на полы и стены, как вертикально, так и горизонтально.



INDEX



OVERVIEW



IMAGE GALLERY



PRIVATE VILLA IN&OUT - Cream, Ivory

LIVING ROOM IN&OUT - Grey

STUDIO&TERRACE - Tarmac

RESIDENTIAL OUTDOOR, KITCHEN

RESIDENTIAL BATHROOM - White

RESIDENTIAL BATHROOM - Ivory

WELLNESS SPA&RELAX - Taupe, Clay

COMMERCIAL RESTROOM - Smoke

FASHION SHOWROOM - Ivory

PRODUCT RANGE & TECHNICAL SPECS.



BOOST WORLD



SUSTAINABILITY



THE BENEFITS OF CERAMIC TILES



FLOOR  
Boost Stone **Grey Grip**  
120x120 cm | 47<sup>1</sup>/<sub>4</sub>"x47<sup>1</sup>/<sub>4</sub>"

OUTDOOR CLADDING  
Boost Stone **Grey Mosaico Brick**  
30x60 cm | 11<sup>3</sup>/<sub>4</sub>"x23<sup>3</sup>/<sub>8</sub>"



FLOOR  
Boost Stone Grey Grip  
120x120 cm | 47 1/4" x 47 1/4"

INDEX



OVERVIEW



IMAGE GALLERY



PRIVATE VILLA IN&OUT - Cream, Ivory

LIVING ROOM IN&OUT - Grey

STUDIO&TERRACE - Tarmac

RESIDENTIAL OUTDOOR, KITCHEN

RESIDENTIAL BATHROOM - White

RESIDENTIAL BATHROOM - Ivory

WELLNESS SPA&RELAX - Taupe, Clay

COMMERCIAL RESTROOM - Smoke

FASHION SHOWROOM - Ivory

PRODUCT RANGE & TECHNICAL SPECS.



BOOST WORLD



SUSTAINABILITY



THE BENEFITS OF CERAMIC TILES







INDEX 

OVERVIEW 

IMAGE GALLERY 

PRIVATE VILLA IN&OUT - Cream, Ivory

LIVING ROOM IN&OUT - Grey

STUDIO&TERRACE - Tarmac

RESIDENTIAL OUTDOOR, KITCHEN

RESIDENTIAL BATHROOM - White

RESIDENTIAL BATHROOM - Ivory

WELLNESS SPA&RELAX - Taupe, Clay

COMMERCIAL RESTROOM - Smoke

FASHION SHOWROOM - Ivory

PRODUCT RANGE & TECHNICAL SPECS. 

BOOST WORLD 

SUSTAINABILITY 

THE BENEFITS OF CERAMIC TILES 

FLOOR  
Boost Stone **Grey Grip**  
120x120 cm | 47<sup>1</sup>/<sub>4</sub>"x47<sup>1</sup>/<sub>4</sub>"

OUTDOOR CLADDING  
Boost Stone **Grey Matte/Matt**  
120x120 cm | 47<sup>1</sup>/<sub>4</sub>"x47<sup>1</sup>/<sub>4</sub>"

Boost Stone **Grey Mosaico Brick**  
30x60 cm | 11<sup>3</sup>/<sub>8</sub>"x23<sup>3</sup>/<sub>8</sub>"

# Cosmopolitan mood.

Neutral tones and the precision of the details give the space a cosmopolitan, contemporary look. Their ability to be perfectly mixed and matched with the colors of the concrete-look Boost collection extends the creative possibilities beyond all limits.

I toni neutri e la precisione dei dettagli donano all'ambiente un look cosmopolita e contemporaneo. La perfetta abbinabilità con le cromie dell'effetto cemento di Boost estende oltre ogni limite le possibilità creative.

Les tons neutres et la précision des détails donnent à l'environnement un aspect cosmopolite et contemporain. La combinaison parfaite avec les couleurs de l'effet béton de Boost étend les possibilités créatives au-delà de toutes les limites.

Die neutralen Farbtöne und präzisen Details verleihen dem Ambiente eine kosmopolitische und kontemporäre Ausstrahlung. Die perfekte Abstimmung auf die Farben der Zementoptik von Boost erweitert das Gestaltungspotenzial ins Unendliche.

Los tonos neutros y los detalles precisos dan al ambiente un aspecto cosmopolita y contemporáneo. La combinación perfecta con los colores de efecto cemento de Boost amplía las posibilidades creativas más allá de todos los límites.

Нейтральные тона и ухоженность деталей придают обстановке современный космополитичный вид. Сочетаемость с цветами плитки под цемент коллекции Boost расширяет дизайнерские возможности до невероятных масштабов.



INDEX 

OVERVIEW 

IMAGE GALLERY 

PRIVATE VILLA IN&OUT - Cream, Ivory

LIVING ROOM IN&OUT - Grey

STUDIO&TERRACE - Tarmac

RESIDENTIAL OUTDOOR, KITCHEN

RESIDENTIAL BATHROOM - White

RESIDENTIAL BATHROOM - Ivory

WELLNESS SPA&RELAX - Taupe, Clay

COMMERCIAL RESTROOM - Smoke

FASHION SHOWROOM - Ivory

PRODUCT RANGE & TECHNICAL SPECS. 

BOOST WORLD 

SUSTAINABILITY 

THE BENEFITS OF CERAMIC TILES 

©



The delicate shading and slight differences in tone of the stone-effect graphics inspired by Argent Roc are well suited to the most refined settings where prestigious details are sought.

Le sfumature delicate e le stonalizzazioni minime delle grafiche effetto pietra ispirate alla Argent Roc trovano la loro destinazione ideale nei contesti più raffinati, dove si ricerca un dettaglio di pregio.

Les tons délicats et le résultat dénuancé minimum des graphismes effet pierre s'inspirant de l'Argent Roc trouvent leur destination idéale dans les contextes les plus raffinés, où un détail précieux est recherché.

Die zarten Nuancen und die minimalen farblichen Abweichungen der am Argent Roc inspirierten Grafiken in Steinoptik finden ihre ideale Verwendung in hocheleganten Kontexten, in denen prestigevolle Details erwartet werden.

Los delicados matices y los contrastes mínimos de los gráficos de efecto piedra inspirados en el Argent Roc encuentran su destino ideal en los contextos más refinados, donde se busca el detalle fino.

Спокойные оттенки и минимальный разнотон рисунка камня Argent Roc идеально подходят для изысканных контекстов, где ценятся престижные детали.



INDEX



OVERVIEW



IMAGE GALLERY



PRIVATE VILLA IN&OUT - Cream, Ivory

LIVING ROOM IN&OUT - Grey

STUDIO&TERRACE - Tarmac

RESIDENTIAL OUTDOOR, KITCHEN

RESIDENTIAL BATHROOM - White

RESIDENTIAL BATHROOM - Ivory

WELLNESS SPA&RELAX - Taupe, Clay

COMMERCIAL RESTROOM - Smoke

FASHION SHOWROOM - Ivory

PRODUCT RANGE & TECHNICAL SPECS.



BOOST WORLD



SUSTAINABILITY



THE BENEFITS OF CERAMIC TILES



FLOOR  
Boost Stone **Pearl** Matte/Matt  
120x120 cm | 47<sup>1</sup>/<sub>4</sub>"x47<sup>1</sup>/<sub>4</sub>"

WALL  
Boost **Pearl** Matte/Matt  
120x278 cm | 47<sup>1</sup>/<sub>4</sub>"x109<sup>1</sup>/<sub>2</sub>"

Boost **Tarmac** Matte/Matt  
120x278 cm | 47<sup>1</sup>/<sub>4</sub>"x109<sup>1</sup>/<sub>2</sub>"



FLOOR  
Boost Stone **Pearl Matte/Matt**  
120x120 cm | 47<sup>1</sup>/<sub>4</sub>"x47<sup>1</sup>/<sub>4</sub>"

WALL  
Boost **Tarmac Matte/Matt**  
120x278 cm | 47<sup>1</sup>/<sub>4</sub>"x109<sup>1</sup>/<sub>2</sub>"

Boost Stone **Pearl Mosaico Hex**  
25x28,5 cm | 9<sup>7</sup>/<sub>8</sub>"x11<sup>1</sup>/<sub>4</sub>"

INDEX



OVERVIEW



IMAGE GALLERY



PRIVATE VILLA IN&OUT - Cream, Ivory

LIVING ROOM IN&OUT - Grey

STUDIO&TERRACE - Tarmac

RESIDENTIAL OUTDOOR, KITCHEN

RESIDENTIAL BATHROOM - White

RESIDENTIAL BATHROOM - Ivory

WELLNESS SPA&RELAX - Taupe, Clay

COMMERCIAL RESTROOM - Smoke

FASHION SHOWROOM - Ivory

PRODUCT RANGE & TECHNICAL SPECS.



BOOST WORLD



SUSTAINABILITY



THE BENEFITS OF CERAMIC TILES





©



©

FLOOR  
 Boost Stone **Pearl** Matte/Matt  
 120x120 cm | 47<sup>1</sup>/<sub>4</sub>"x47<sup>1</sup>/<sub>4</sub>"

WALL  
 Boost **Tarmac** Matte/Matt  
 120x278 cm | 47<sup>1</sup>/<sub>4</sub>"x109<sup>1</sup>/<sub>2</sub>"

Boost **Pearl** Matte/Matt  
 120x278 cm | 47<sup>1</sup>/<sub>4</sub>"x109<sup>1</sup>/<sub>2</sub>"

Boost Stone **Pearl Mosaico Hex**  
 25x28,5 cm | 9<sup>7</sup>/<sub>8</sub>"x11<sup>1</sup>/<sub>4</sub>"

INDEX



OVERVIEW



IMAGE GALLERY



PRIVATE VILLA IN&OUT - Cream, Ivory

LIVING ROOM IN&OUT - Grey

STUDIO&TERRACE - Tarmac

RESIDENTIAL OUTDOOR, KITCHEN

RESIDENTIAL BATHROOM - White

RESIDENTIAL BATHROOM - Ivory

WELLNESS SPA&RELAX - Taupe, Clay

COMMERCIAL RESTROOM - Smoke

FASHION SHOWROOM - Ivory

PRODUCT RANGE & TECHNICAL SPECS.



BOOST WORLD



SUSTAINABILITY



THE BENEFITS OF CERAMIC TILES





# Creative essence.

The neutral yet decisive tones of the surfaces give each room a contemporary accent. Thanks to their essential look, they revive the design potential of the stone effect in interior design.

Le tonalità neutre ma decise delle superfici caratterizzano ogni ambiente con un accento contemporaneo. Grazie al loro look essenziale, rilanciano le potenzialità progettuali dell'effetto pietra nell'interior design.

Les teintes neutres mais décidées des surfaces caractérisent chaque pièce avec un accent contemporain. Grâce à leur look essentiel, ils relancent le potentiel de design de l'effet pierre en décoration d'intérieur.

Die neutralen und dennoch entschlossenen Farbtöne des Belags prägen jeden Raum mit einer kontemporären Note. Mit ihrem schlichten Look steigern sie das Planungspotenzial der Steinoptik im Innendesign.

Los tonos neutros pero fuertes de las superficies caracterizan cada habitación con un acento contemporáneo. Gracias a su estilo básico, reviven el potencial de diseño del efecto piedra en la decoración de interiores.

Нейтральные, но в то же время решительные тона вносят в интерьер современный акцент. Благодаря лаконичному рисунку поверхности плитка под камень идеальна для создания стильной обстановки.

INDEX



OVERVIEW



IMAGE GALLERY



PRIVATE VILLA IN&OUT - Cream, Ivory

LIVING ROOM IN&OUT - Grey

STUDIO&TERRACE - Tarmac

RESIDENTIAL OUTDOOR, KITCHEN

RESIDENTIAL BATHROOM - White

RESIDENTIAL BATHROOM - Ivory

WELLNESS SPA&RELAX - Taupe, Clay

COMMERCIAL RESTROOM - Smoke

FASHION SHOWROOM - Ivory

PRODUCT RANGE & TECHNICAL SPECS.



BOOST WORLD



SUSTAINABILITY



THE BENEFITS OF CERAMIC TILES





FLOOR  
 Boost Stone **Tarmac** Matte/Matt  
 120x120 cm | 47 1/4" x 47 1/4"



INDEX



OVERVIEW



IMAGE GALLERY



PRIVATE VILLA IN&OUT - Cream, Ivory

LIVING ROOM IN&OUT - Grey

STUDIO&TERRACE - Tarmac

RESIDENTIAL OUTDOOR, KITCHEN

RESIDENTIAL BATHROOM - White

RESIDENTIAL BATHROOM - Ivory

WELLNESS SPA&RELAX - Taupe, Clay

COMMERCIAL RESTROOM - Smoke

FASHION SHOWROOM - Ivory

PRODUCT RANGE & TECHNICAL SPECS.



BOOST WORLD



SUSTAINABILITY



THE BENEFITS OF CERAMIC TILES



The large 120x278 format is perfectly modular to the floor and expands the creative potential of simple, elegant interiors. The natural finish fully exploits the stone effect, maintaining its typical opacity.

Il grande formato 120x278 è perfettamente modulare al pavimento, e amplia le potenzialità creative di interni sobri ed eleganti. La finitura naturale valorizza al meglio l'effetto pietra, mantenendone la tipica opacità.

Le grand format 120x278 est parfaitement modulable au sol, et élargit le potentiel créatif d'intérieurs sobres et élégants. La finition naturelle améliore au mieux l'effet pierre, en conservant son opacité typique.

Das Großformat 120x278 ist mit dem Bodenbelag perfekt modular und erweitert das kreative Potenzial für schlicht elegante Innenräume. Die natürliche Oberflächenausführung bringt die Steinoptik mit der für sie typischen Mattheit maximal zur Geltung.

El tamaño grande 120x278 combina perfectamente con el pavimento y amplía el potencial creativo de interiores sobrios y elegantes. El acabado natural aprovecha al máximo el efecto piedra, manteniendo su típica opacidad.

Большой формат 120x278 сочетается по размерам с напольной плиткой, чем придает интерьерам строгую элегантность. Натуральная отделка поверхности максимально раскрывает красоту рисунка камня, сохраняя характерную матовость.

FLOOR  
Boost Stone **Tarmac** Matte/Matt  
120x120 cm | 47 1/4" x 47 1/4"

WALL  
Boost Stone **Smoke** Matte/Matt  
120x278 cm | 47 1/4" x 109 1/2"



INDEX



OVERVIEW



IMAGE GALLERY



PRIVATE VILLA IN&OUT - Cream, Ivory

LIVING ROOM IN&OUT - Grey

STUDIO&TERRACE - Tarmac

RESIDENTIAL OUTDOOR, KITCHEN

RESIDENTIAL BATHROOM - White

RESIDENTIAL BATHROOM - Ivory

WELLNESS SPA&RELAX - Taupe, Clay

COMMERCIAL RESTROOM - Smoke

FASHION SHOWROOM - Ivory

PRODUCT RANGE & TECHNICAL SPECS.



BOOST WORLD



SUSTAINABILITY



THE BENEFITS OF CERAMIC TILES







FLOOR  
 Boost Stone **Tarmac** Matte/Matt  
 120x120 cm | 47<sup>1</sup>/<sub>4</sub>"x47<sup>1</sup>/<sub>4</sub>"

WALL  
 Boost Stone **Smoke** Matte/Matt  
 120x278 cm | 47<sup>1</sup>/<sub>4</sub>"x109<sup>1</sup>/<sub>2</sub>"

Boost **Pearl** Matte/Matt  
 120x278 cm | 47<sup>1</sup>/<sub>4</sub>"x109<sup>1</sup>/<sub>2</sub>"

INDEX



OVERVIEW



IMAGE GALLERY



PRIVATE VILLA IN&OUT - Cream, Ivory

LIVING ROOM IN&OUT - Grey

STUDIO&TERRACE - Tarmac

RESIDENTIAL OUTDOOR, KITCHEN

RESIDENTIAL BATHROOM - White

RESIDENTIAL BATHROOM - Ivory

WELLNESS SPA&RELAX - Taupe, Clay

COMMERCIAL RESTROOM - Smoke

FASHION SHOWROOM - Ivory

PRODUCT RANGE & TECHNICAL SPECS.



BOOST WORLD



SUSTAINABILITY



THE BENEFITS OF CERAMIC TILES





INDEX



OVERVIEW



IMAGE GALLERY



PRIVATE VILLA IN&OUT - Cream, Ivory

LIVING ROOM IN&OUT - Grey

STUDIO&TERRACE - Tarmac

RESIDENTIAL OUTDOOR, KITCHEN

RESIDENTIAL BATHROOM - White

RESIDENTIAL BATHROOM - Ivory

WELLNESS SPA&RELAX - Taupe, Clay

COMMERCIAL RESTROOM - Smoke

FASHION SHOWROOM - Ivory

PRODUCT RANGE & TECHNICAL SPECS.



BOOST WORLD



SUSTAINABILITY



THE BENEFITS OF CERAMIC TILES



# Maximum Expression.

The surfaces are extremely versatile. Outside they can also be used to design ventilated facades. Inside they adapt to worktops, backsplashes, and tables of all sizes.

Le superfici sono estremamente versatili. In esterno, possono essere impiegate anche per la progettazione di facciate ventilate. In interno, si adattano a piani lavoro, backsplash e tavoli di ogni dimensione.

Ces surfaces sont extrêmement polyvalentes. En extérieur, elles peuvent également être utilisées pour la conception de façades ventilées. En intérieur, elles s'adaptent aux plans de travail, dossierets et tables de toutes dimensions.

Die Oberflächen sind extrem vielseitig. Im Freien können sie auch für hinterlüftete Fassaden verwendet werden. Im Innenbereich eignen sie sich für Arbeitsplatten, Küchenrückwände und Tische jeder Größe.

Las superficies son extremadamente versátiles. En exteriores, también pueden utilizarse para diseñar fachadas ventiladas. En interiores, son buenas para encimeras, salpicaderos y mesas de todos los tamaños.

Плитка многофункциональна. В наружных пространствах ею можно облицовывать также вентилируемые фасады. В интерьерах она подходит для покрытия столешниц, фартуков, столов любого размера.

FLOOR  
Boost Stone **Grey** Outdoor 20 mm  
120x120 cm | 47<sup>1</sup>/<sub>8</sub>"x47<sup>1</sup>/<sub>8</sub>"

VENTILATED FACADE  
Boost Stone **White** Matte/Matt  
60x120 cm | 23<sup>3</sup>/<sub>8</sub>"x47<sup>1</sup>/<sub>8</sub>"



FLOOR  
Boost Natural **Ecrú** Matte/Matt  
120x120 cm | 47<sup>1</sup>/<sub>4</sub>"x47<sup>1</sup>/<sub>4</sub>"

WALL  
Boost Natural **Ecrú** Matte/Matt  
120x278 cm | 47<sup>1</sup>/<sub>4</sub>"x109<sup>1</sup>/<sub>2</sub>"

COUNTERTOP  
**AtlasPlan**  
Boost Stone **Ivory** Hammered  $\pm$  12 mm  
162x324 cm | 63<sup>3</sup>/<sub>4</sub>"x127<sup>1</sup>/<sub>2</sub>"

CABINET DOORS  
Boost Stone **Ivory** Matte/Matt  $\pm$  6 mm

©

INDEX



OVERVIEW



IMAGE GALLERY



- PRIVATE VILLA IN&OUT - Cream, Ivory
- LIVING ROOM IN&OUT - Grey
- STUDIO&TERRACE - Tarmac
- RESIDENTIAL OUTDOOR, KITCHEN
- RESIDENTIAL BATHROOM - White
- RESIDENTIAL BATHROOM - Ivory
- WELLNESS SPA&RELAX - Taupe, Clay
- COMMERCIAL RESTROOM - Smoke
- FASHION SHOWROOM - Ivory

PRODUCT RANGE & TECHNICAL SPECS.



BOOST WORLD



SUSTAINABILITY



THE BENEFITS OF CERAMIC TILES





FLOOR  
Boost Natural **Ecreu** Matte/Matt  
120x120 cm | 47<sup>1</sup>/<sub>4</sub>"x47<sup>1</sup>/<sub>4</sub>"

WALL  
Boost Natural **Ecreu** Matte/Matt  
120x278 cm | 47<sup>1</sup>/<sub>4</sub>"x109<sup>1</sup>/<sub>2</sub>"

COUNTERTOP  
**AtlasPlan**  
Boost Stone **Ivory** Hammered  $\pm$  12 mm  
162x324 cm | 63<sup>3</sup>/<sub>4</sub>"x127<sup>1</sup>/<sub>2</sub>"

CABINET DOORS  
Boost Stone **Ivory** Matte/Matt  $\pm$  6 mm

INDEX



OVERVIEW



IMAGE GALLERY



- PRIVATE VILLA IN&OUT - Cream, Ivory
- LIVING ROOM IN&OUT - Grey
- STUDIO&TERRACE - Tarmac
- RESIDENTIAL OUTDOOR, KITCHEN
- RESIDENTIAL BATHROOM - White
- RESIDENTIAL BATHROOM - Ivory
- WELLNESS SPA&RELAX - Taupe, Clay
- COMMERCIAL RESTROOM - Smoke
- FASHION SHOWROOM - Ivory

PRODUCT RANGE & TECHNICAL SPECS.



BOOST WORLD



SUSTAINABILITY



THE BENEFITS OF CERAMIC TILES





# Aesthetic vibration.

Thanks to their versatility, the surfaces can be used both to design total-look environments and to create spaces where the stone effect coexists harmoniously with other materials.

Grazie alla loro versatilità, le superfici possono essere utilizzate sia per progettare ambienti total look che per creare spazi dove l'effetto pietra convive armonicamente con altri materiali.

Grâce à leur polyvalence, les surfaces peuvent être utilisées à la fois pour concevoir des environnements au look total et pour créer des espaces où l'effet pierre coexiste harmonieusement avec d'autres matériaux.

Dank ihrer Vielseitigkeit sind die Beläge sowohl für Räume im Total Look verwendbar als auch für einen harmonischen Mix der Steinoptik mit anderen Materialien.

Gracias a su versatilidad, las superficies pueden utilizarse tanto para diseñar ambientes con un estilo acabado como para crear espacios en los que el efecto de la piedra conviva armoniosamente con otros materiales.

Благодаря ее универсальности плитку под камень можно использовать как для оформления интерьера в стиле тотал-лук, так и для сочетания с другими материалами.

INDEX



OVERVIEW



IMAGE GALLERY



PRIVATE VILLA IN&OUT - Cream, Ivory

LIVING ROOM IN&OUT - Grey

STUDIO&TERRACE - Tarmac

RESIDENTIAL OUTDOOR, KITCHEN

RESIDENTIAL BATHROOM - White

RESIDENTIAL BATHROOM - Ivory

WELLNESS SPA&RELAX - Taupe, Clay

COMMERCIAL RESTROOM - Smoke

FASHION SHOWROOM - Ivory

PRODUCT RANGE & TECHNICAL SPECS.



BOOST WORLD



SUSTAINABILITY



THE BENEFITS OF CERAMIC TILES





FLOOR  
Boost Stone **White** Matte/Matt  
120x120 cm | 47<sup>5</sup>/<sub>8</sub>"x47<sup>5</sup>/<sub>8</sub>"

WALL  
Boost Stone **White** Matte/Matt  
60x120 cm | 23<sup>5</sup>/<sub>8</sub>"x47<sup>5</sup>/<sub>8</sub>"

Boost **Pearl** Matte/Matt  
60x120 cm | 23<sup>5</sup>/<sub>8</sub>"x47<sup>5</sup>/<sub>8</sub>"

SHOWER  
Boost Stone **Mosaico Cube Cold**  
30x30 cm | 11<sup>3</sup>/<sub>4</sub>"x11<sup>3</sup>/<sub>4</sub>"

TOP/SHELVES  
Boost **Smoke** Matte/Matt

INDEX



OVERVIEW



IMAGE GALLERY



- PRIVATE VILLA IN&OUT - Cream, Ivory
- LIVING ROOM IN&OUT - Grey
- STUDIO&TERRACE - Tarmac
- RESIDENTIAL OUTDOOR, KITCHEN
- RESIDENTIAL BATHROOM - White
- RESIDENTIAL BATHROOM - Ivory
- WELLNESS SPA&RELAX - Taupe, Clay
- COMMERCIAL RESTROOM - Smoke
- FASHION SHOWROOM - Ivory

PRODUCT RANGE & TECHNICAL SPECS.



BOOST WORLD



SUSTAINABILITY



THE BENEFITS OF CERAMIC TILES





©

The soft shades of Boost Stone convey a feeling of comfort that is perfect for the walls and floors of a space dedicated to body care. A delicate, suffused vibration crosses the surfaces with an effect of authenticity and realism.

Le tonalità morbide di Boost Stone trasmettono una sensazione di comfort perfetta per le pareti e i pavimenti di uno spazio dedicato alla cura del corpo. Una delicata vibrazione diffusa attraversa le superfici con un effetto di autenticità e realismo.

Les tons doux de Boost Stone transmettent une sensation de confort parfaite pour les murs et les sols d'un espace dédié aux soins du corps. Une délicate vibration diffuse traverse les surfaces avec un effet d'authenticité et de réalisme.

Die weichen Farbtöne von Boost Stone an Boden und Wand vermitteln ein Gefühl vollkommenen Komforts in der Körperpflege gewidmeten Räumen. Zarte, diffuse Schwingungen durchziehen die Oberflächen und erzeugen den Eindruck von Authentizität und Realismus.

Los tonos suaves de Boost Stone transmiten una sensación de confort que es perfecta para las paredes y los suelos de un espacio dedicado al cuidado del cuerpo. Una delicada vibración recorre las superficies con un efecto de autenticidad y realismo.

Мягкие тона Boost Stone дарят ощущение комфорта, поэтому идеально подходят для облицовки полов и стен в ванных комнатах. Деликатная фактура поверхностей аутентична и реалистична.



FLOOR  
Boost Stone **White** Matte/Matt  
120x120 cm | 47<sup>1</sup>/<sub>8</sub>"x47<sup>1</sup>/<sub>8</sub>"

WALL  
Boost Stone **White** Matte/Matt  
60x120 cm | 23<sup>5</sup>/<sub>8</sub>"x47<sup>1</sup>/<sub>8</sub>"

TOP/SHELVES  
Boost **Smoke** Matte/Matt

©

INDEX



OVERVIEW

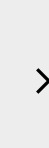

IMAGE GALLERY



- PRIVATE VILLA IN&OUT - Cream, Ivory
- LIVING ROOM IN&OUT - Grey
- STUDIO&TERRACE - Tarmac
- RESIDENTIAL OUTDOOR, KITCHEN
- RESIDENTIAL BATHROOM - White
- RESIDENTIAL BATHROOM - Ivory
- WELLNESS SPA&RELAX - Taupe, Clay
- COMMERCIAL RESTROOM - Smoke
- FASHION SHOWROOM - Ivory

PRODUCT RANGE & TECHNICAL SPECS.



BOOST WORLD



SUSTAINABILITY



THE BENEFITS OF CERAMIC TILES





INDEX



OVERVIEW



IMAGE GALLERY



- PRIVATE VILLA IN&OUT - Cream, Ivory
- LIVING ROOM IN&OUT - Grey
- STUDIO&TERRACE - Tarmac
- RESIDENTIAL OUTDOOR, KITCHEN
- RESIDENTIAL BATHROOM - White
- RESIDENTIAL BATHROOM - Ivory
- WELLNESS SPA&RELAX - Taupe, Clay
- COMMERCIAL RESTROOM - Smoke
- FASHION SHOWROOM - Ivory

PRODUCT RANGE & TECHNICAL SPECS.



BOOST WORLD



SUSTAINABILITY



THE BENEFITS OF CERAMIC TILES



SHOWER  
 Boost Stone **Mosaico Cube Cold**  
 30x30 cm | 11<sup>3</sup>/<sub>4</sub>"x11<sup>3</sup>/<sub>4</sub>"





## A matter of detail.

The compact base of the stone-effect surface adds uniformity to the bathroom floor. The precision of the graphics is evident in every detail and faithfully reproduces the tones, contrasts, and irregularities typical of the original material.

Il fondo compatto della superficie effetto pietra dona omogeneità al pavimento del bagno. La precisione della grafica è curata nei minimi particolari e riproduce con fedeltà i toni, i contrasti e le irregolarità tipiche della materia di ispirazione.

La base compacte de la surface effet pierre donne une homogénéité au sol de la salle de bain. La précision du graphisme est soignée dans les moindres détails et reproduit fidèlement les tons, les contrastes et les irrégularités typiques de la matière d'inspiration.

Der gleichmäßige Untergrund des Belags in Steinoptik verleiht dem Badezimmerboden ein einheitliches Aussehen. Die Präzision der Grafik ist bis ins kleinste Detail mit großer Sorgfalt ausgeführt und reproduziert getreu Farbtöne, Kontraste und Unregelmäßigkeiten des als Vorbild dienenden Materials.

El fondo compacto de la superficie con efecto piedra da al suelo del baño un aspecto homogéneo. La precisión de la parte gráfica pone atención a los más mínimos detalles y reproduce fielmente los tonos, los contrastes y las irregularidades propios del material de inspiración.

Плотный фон плитки под камень придает полу в ванной комнате приятную однородность. Ухоженный до мельчайших деталей рисунок с точностью воспроизводит тона, контрасты, неправильность рисунка исходных образцов материала.

INDEX



OVERVIEW



IMAGE GALLERY



PRIVATE VILLA IN&OUT - Cream, Ivory

LIVING ROOM IN&OUT - Grey

STUDIO&TERRACE - Tarmac

RESIDENTIAL OUTDOOR, KITCHEN

RESIDENTIAL BATHROOM - White

RESIDENTIAL BATHROOM - Ivory

WELLNESS SPA&RELAX - Taupe, Clay

COMMERCIAL RESTROOM - Smoke

FASHION SHOWROOM - Ivory

PRODUCT RANGE & TECHNICAL SPECS.



BOOST WORLD



SUSTAINABILITY



THE BENEFITS OF CERAMIC TILES





Mosaico Hex enriches the surfaces of the collection with a pattern of hexagonal tiles. With its soft tones it envelops the surface of the bathroom wall, heightening the feeling of comfort.

Il Mosaico Hex arricchisce le superfici della collezione con una trama di tessere esagonali. Con le sue tonalità morbide avvolge la superficie della parete del bagno, esaltando la sensazione di comfort.

La Mosaïque Hex enrichit les surfaces de la collection avec une texture de carreaux hexagonaux. Avec ses teintes douces, elle enveloppe la surface du mur de la salle de bain, améliorant la sensation de confort.

Das Mosaik Hex bereichert die Kollektion mit seinen sechseckigen Mosaiksteinchen. Mit seinen weichen Farbtönen kleidet es die Wand im Bad und steigert die Empfindung von echtem Komfort.

El Mosaico Hex enriquece las superficies de la colección con una trama de azulejos hexagonales. Con sus suaves tonos, envuelve la superficie de la pared del baño, aumentando la sensación de confort.

Мозаика Нех обогащает поверхности узором из шестиугольных элементов. Ее мягкие тона окутывают стены ванной, усиливая ощущение уюта.

WALL  
Boost Stone **Ivory Mosaico Hex**  
25x28.5 cm | 9<sup>7</sup>/<sub>8</sub>”x11<sup>1</sup>/<sub>4</sub>”

SHOWER  
Boost Pro **Clay Matte/Matt**  
120x278 cm | 47<sup>1</sup>/<sub>4</sub>”x109<sup>1</sup>/<sub>2</sub>”

FLOOR  
Boost Stone **Ivory Matte/Matt**  
120x120 cm | 47<sup>1</sup>/<sub>4</sub>”x47<sup>1</sup>/<sub>4</sub>”

Exence **Amber Matte/Matt**  
18,5x150 cm | 7<sup>1</sup>/<sub>4</sub>”x59”



INDEX



OVERVIEW



IMAGE GALLERY



PRIVATE VILLA IN&OUT - Cream, Ivory

LIVING ROOM IN&OUT - Grey

STUDIO&TERRACE - Tarmac

RESIDENTIAL OUTDOOR, KITCHEN

RESIDENTIAL BATHROOM - White

RESIDENTIAL BATHROOM - Ivory

WELLNESS SPA&RELAX - Taupe, Clay

COMMERCIAL RESTROOM - Smoke

FASHION SHOWROOM - Ivory

PRODUCT RANGE & TECHNICAL SPECS.



BOOST WORLD



SUSTAINABILITY



THE BENEFITS OF CERAMIC TILES





WALL  
 Boost Stone **Ivory** Matte/Matt  
 60x120 cm | 23<sup>5</sup>/<sub>8</sub>"x47<sup>1</sup>/<sub>4</sub>"

INDEX 

OVERVIEW 

IMAGE GALLERY 

PRIVATE VILLA IN&OUT - Cream, Ivory

LIVING ROOM IN&OUT - Grey

STUDIO&TERRACE - Tarmac

RESIDENTIAL OUTDOOR, KITCHEN

RESIDENTIAL BATHROOM - White

RESIDENTIAL BATHROOM - Ivory

WELLNESS SPA&RELAX - Taupe, Clay

COMMERCIAL RESTROOM - Smoke

FASHION SHOWROOM - Ivory

PRODUCT RANGE & TECHNICAL SPECS. 

BOOST WORLD 

SUSTAINABILITY 

THE BENEFITS OF CERAMIC TILES 

— Boost Stone

Boost Stone offers designers the possibility of creating stone-effect sinks coordinated with all the surfaces of the environment, combining beauty and superior performance in every situation.

Boost Stone offre ai progettisti la possibilità di realizzare lavabi effetto pietra coordinati a tutte le superfici dell'ambiente, coniugando bellezza e performance elevate in ogni situazione.

Boost Stone offre aux designers la possibilité de créer des lavabos effet pierre coordonnés avec toutes les surfaces de l'environnement, alliant beauté et haute performance dans toutes les situations.

Boost Stone bietet dem Planer die Möglichkeit, Waschbecken mit Steinoptik auf alle Oberflächen des Raums abzustimmen und damit große Schönheit und Leistungen zu vereinen.

Boost Stone ofrece a los diseñadores la posibilidad de crear lavabos de efecto piedra combinados con todas las superficies del ambiente de manera tal de reunir la belleza y un alto rendimiento en cada caso.

Boost Stone предоставляет дизайнерам возможность выбирать умывальники с той же фактурой камня, которая покрывает остальные поверхности интерьера, сочетая красоту и высокие эксплуатационные свойства.



©



Image Gallery — Residential Bathroom

INDEX



OVERVIEW



IMAGE GALLERY



- PRIVATE VILLA IN&OUT - Cream, Ivory
- LIVING ROOM IN&OUT - Grey
- STUDIO&TERRACE - Tarmac
- RESIDENTIAL OUTDOOR, KITCHEN
- RESIDENTIAL BATHROOM - White
- RESIDENTIAL BATHROOM - Ivory
- WELLNESS SPA&RELAX - Taupe, Clay
- COMMERCIAL RESTROOM - Smoke
- FASHION SHOWROOM - Ivory

PRODUCT RANGE & TECHNICAL SPECS.



BOOST WORLD



SUSTAINABILITY



THE BENEFITS OF CERAMIC TILES



SINK  
Boost Stone Ivory Matte/Matt

TOP/SHELF  
Boost Pro Clay Matte/Matt

©



INDEX 

OVERVIEW 

IMAGE GALLERY 

PRIVATE VILLA IN&OUT - Cream, Ivory

LIVING ROOM IN&OUT - Grey

STUDIO&TERRACE - Tarmac

RESIDENTIAL OUTDOOR, KITCHEN

RESIDENTIAL BATHROOM - White

RESIDENTIAL BATHROOM - Ivory

WELLNESS SPA&RELAX - Taupe, Clay

COMMERCIAL RESTROOM - Smoke

FASHION SHOWROOM - Ivory

PRODUCT RANGE & TECHNICAL SPECS. 

BOOST WORLD 

SUSTAINABILITY 

THE BENEFITS OF CERAMIC TILES 

FLOOR  
Boost Stone **Ivory** Matte/Matt  
120x120 cm | 47 1/4" x 47 1/4"





# Natural suspension.

The 9 mm floor formats are available in a matte finish that reproduces the natural vibrancy of stone. The tile reinterprets the opacity and pleasantness of the original material without altering its non-slip surface or compromising its ease of cleaning.

I formati da pavimento a 9 mm sono disponibili nella finitura matt che ripropone la naturale matericità della pietra. La superficie reinterpreta l'opacità e la gradevolezza della materia di ispirazione, senza alterare la resistenza allo scivolamento o compromettere la facilità di pulizia.

Les formats de sol de 9 mm sont disponibles dans la finition mate qui repropose le mouvement naturel de la pierre. La surface réinterprète l'opacité et le confort du matériau d'inspiration, sans altérer la résistance au glissement ni compromettre la facilité de nettoyage.

Die 9 mm starken Bodenformate sind mit einer matten Oberfläche erhältlich, die die natürliche Beschaffenheit des Steins wiedergibt. Der Belag interpretiert die Opazität und den Charme des als Vorbild dienenden Materials, ohne deswegen weniger rutschfest oder reinigungsfreundlich zu sein.

Los tamaños de pavimento de 9 mm están disponibles en el acabado mate que vuelve a proponer la motricidad natural de la piedra. La superficie reinterpreta la opacidad y la belleza del material de inspiración sin alterar su carácter antideslizante ni comprometer la facilidad de limpieza.

Напольные форматы толщиной 9 мм доступны в матовом варианте поверхности, как у природного камня. При этом приятная фактура плиток препятствует скольжению и проста в уходе.

INDEX



OVERVIEW



IMAGE GALLERY



PRIVATE VILLA IN&OUT - Cream, Ivory

LIVING ROOM IN&OUT - Grey

STUDIO&TERRACE - Tarmac

RESIDENTIAL OUTDOOR, KITCHEN

RESIDENTIAL BATHROOM - White

RESIDENTIAL BATHROOM - Ivory

WELLNESS SPA&RELAX - Taupe, Clay

COMMERCIAL RESTROOM - Smoke

FASHION SHOWROOM - Ivory

PRODUCT RANGE & TECHNICAL SPECS.



BOOST WORLD



SUSTAINABILITY



THE BENEFITS OF CERAMIC TILES





©

FLOOR  
Boost Stone **Taupe** Matte/Matt  
120x120 cm | 47<sup>1</sup>/<sub>4</sub>"x47<sup>1</sup>/<sub>4</sub>"

WALL  
Boost Stone **Ivory** Matte/Matt  
120x278 cm | 47<sup>1</sup>/<sub>4</sub>"x109<sup>1</sup>/<sub>2</sub>"

BATHTUB  
Boost Stone **Ivory** Matte/Matt



©

INDEX



OVERVIEW



IMAGE GALLERY



- PRIVATE VILLA IN&OUT - Cream, Ivory
- LIVING ROOM IN&OUT - Grey
- STUDIO&TERRACE - Tarmac
- RESIDENTIAL OUTDOOR, KITCHEN
- RESIDENTIAL BATHROOM - White
- RESIDENTIAL BATHROOM - Ivory
- WELLNESS SPA&RELAX - Taupe, Clay
- COMMERCIAL RESTROOM - Smoke
- FASHION SHOWROOM - Ivory

PRODUCT RANGE & TECHNICAL SPECS.



BOOST WORLD



SUSTAINABILITY



THE BENEFITS OF CERAMIC TILES





©

Porcelain tiles are a solution suitable for all bathroom surfaces, from floors to walls and sinks. They're easy to clean, waterproof, resistant to stains and abrasions, and prevent the formation of germs and bacteria.

Il gres porcellanato è una soluzione adatta a tutte le superfici del bagno, dal pavimento fino alle pareti e ai lavabi. Si pulisce facilmente, è impermeabile, resiste a macchie e abrasioni e previene la formazione di germi e batteri.

Le grès cérame est une solution adaptée à toutes les surfaces de salle de bain, du sol aux murs et aux lavabos. Il se nettoie facilement, est imperméable, résiste aux taches et à l'abrasion et prévient la formation de germes et de bactéries.

Feinsteinzeug eignet sich für alle Oberflächen im Bad: vom Boden bis zu den Wänden und Waschbecken. Es ist einfach zu reinigen, undurchlässig, flecken- und abriebbeständig und hemmt die Bildung von Keimen und Bakterien.

El gres porcelánico es adecuado para todas las superficies del baño, desde el pavimento hasta las paredes y los lavabos. Es fácil de limpiar, impermeable, resistente a las manchas y abrasiones y evita el crecimiento de gérmenes y bacterias.

Керамогранит – идеальное решение для всех поверхностей ванной, от полов и стен до умывальников. Он легко чистится, непроницаем для воды и влаги, устойчив к пятнам и износу, препятствует образованию микробов и бактерий.



©

FLOOR  
Boost Stone **Taupe** Matte/Matt  
120x120 cm | 47 1/4"x47 1/4"

WALL  
Boost Stone **Clay** Matte/Matt  
120x278 cm | 47 1/4"x109 1/2"

Boost Stone **Ivory** Matte/Matt  
120x278 cm | 47 1/4"x109 1/2"

SINK, TOP/SHELF  
Boost Stone **Ivory** Matte/Matt

INDEX



OVERVIEW



IMAGE GALLERY



- PRIVATE VILLA IN&OUT - Cream, Ivory
- LIVING ROOM IN&OUT - Grey
- STUDIO&TERRACE - Tarmac
- RESIDENTIAL OUTDOOR, KITCHEN
- RESIDENTIAL BATHROOM - White
- RESIDENTIAL BATHROOM - Ivory
- WELLNESS SPA&RELAX - Taupe, Clay
- COMMERCIAL RESTROOM - Smoke
- FASHION SHOWROOM - Ivory

PRODUCT RANGE & TECHNICAL SPECS.



BOOST WORLD



SUSTAINABILITY



THE BENEFITS OF CERAMIC TILES







©



©

FLOOR  
Boost Stone **Taupe** Matte/Matt  
120x120 cm | 47<sup>1</sup>/<sub>4</sub>"x47<sup>1</sup>/<sub>4</sub>"

WALL  
Boost Stone **Clay** Matte/Matt  
120x278 cm | 47<sup>1</sup>/<sub>4</sub>"x109<sup>1</sup>/<sub>2</sub>"

SINK, TOP  
Boost Stone **Ivory** Matte/Matt

INDEX



OVERVIEW



IMAGE GALLERY



- PRIVATE VILLA IN&OUT - Cream, Ivory
- LIVING ROOM IN&OUT - Grey
- STUDIO&TERRACE - Tarmac
- RESIDENTIAL OUTDOOR, KITCHEN
- RESIDENTIAL BATHROOM - White
- RESIDENTIAL BATHROOM - Ivory
- WELLNESS SPA&RELAX - Taupe, Clay
- COMMERCIAL RESTROOM - Smoke
- FASHION SHOWROOM - Ivory

PRODUCT RANGE & TECHNICAL SPECS.



BOOST WORLD



SUSTAINABILITY



THE BENEFITS OF CERAMIC TILES





INDEX



OVERVIEW



IMAGE GALLERY



PRIVATE VILLA IN&OUT - Cream, Ivory

LIVING ROOM IN&OUT - Grey

STUDIO&TERRACE - Tarmac

RESIDENTIAL OUTDOOR, KITCHEN

RESIDENTIAL BATHROOM - White

RESIDENTIAL BATHROOM - Ivory

WELLNESS SPA&RELAX - Taupe, Clay

COMMERCIAL RESTROOM - Smoke

FASHION SHOWROOM - Ivory

PRODUCT RANGE & TECHNICAL SPECS.



BOOST WORLD



SUSTAINABILITY



THE BENEFITS OF CERAMIC TILES



# Refined harmony.

The contrast of light shades on the walls and dark tones on the floor highlights the volumes in the room. The grains of the stone-effect texture stand out for their uniqueness and give the space a refined appearance.

L'accostamento delle sfumature chiare del rivestimento a quelle scure del pavimento evidenzia i volumi con un gioco di contrasti. I grani della texture effetto pietra risaltano per la loro unicità e conferiscono allo spazio un aspetto ricercato.

L'association des tons clairs du revêtement avec les tons foncés du sol met en valeur les volumes par un jeu de contrastes. Les grains de la texture effet pierre se distinguent par leur caractère unique et donnent à l'espace un aspect raffiné.

Die Kombination der hellen Wandverkleidung mit dem dunklen Bodenbelag unterstreicht die Volumen in einem Spiel aus Kontrasten. Die Körner der Steinoptik-Textur heben sich durch ihre Einzigartigkeit ab und verleihen dem Raum ein elegantes Aussehen.

La combinación de los tonos claros del revestimiento con los tonos oscuros del pavimento resaltan los volúmenes con un juego de contrastes. Las vetas de la textura con efecto piedra se destacan por su singularidad y crean un aspecto refinado.

Сочетание светлых тонов стен и темных оттенков полов подчеркивает объемы элегантной игрой контрастов. Зернистый рисунок камня уникален и придает интерьеру изысканный вид.



©

FLOOR  
Boost Stone **Smoke** Matte/Matt  
120x120 cm | 47 1/4" x 47 1/4"

WALL  
Boost **White** Matte/Matt  
120x278 cm | 47 1/4" x 109 1/2"

SINK  
Boost Stone **Smoke** Matte/Matt



©

INDEX



OVERVIEW



IMAGE GALLERY



- PRIVATE VILLA IN&OUT - Cream, Ivory
- LIVING ROOM IN&OUT - Grey
- STUDIO&TERRACE - Tarmac
- RESIDENTIAL OUTDOOR, KITCHEN
- RESIDENTIAL BATHROOM - White
- RESIDENTIAL BATHROOM - Ivory
- WELLNESS SPA&RELAX - Taupe, Clay
- COMMERCIAL RESTROOM - Smoke
- FASHION SHOWROOM - Ivory

PRODUCT RANGE & TECHNICAL SPECS.



BOOST WORLD



SUSTAINABILITY



THE BENEFITS OF CERAMIC TILES





The Cube mosaic features a variety of colors and geometric shapes, exploiting different surface effects and textures. It can be laid on the wall or floor, creating different installation layouts with a strong visual impact.

Il Mosaico Cube costruisce variazioni geometriche e cromatiche, sfruttando effetti di superficie e texture differenti. Può essere posato a parete o pavimento, creando differenti schemi di posa dal forte impatto visivo.

La Mosaïque Cube construit des variations géométriques et chromatiques, exploitant différents effets de surface et textures. Il peut être posé au mur ou au sol, créant différents motifs de pose avec un fort impact visuel.

Das Mosaik Cube konstruiert aus unterschiedlichen Oberflächeneffekten und Texturen geometrische und farbliche Variationen. Es kann an Wand und Boden verlegt werden, mit verschiedenen, stets optisch effektvollen Verlegemustern.

El mosaico Cube crea variaciones geométricas y cromáticas gracias a los distintos efectos de las superficies y las texturas. Se puede colocar en las paredes o en el pavimento creando diferentes patrones de colocación con un fuerte impacto visual.

Мозаика Cube образует геометрические и цветовые вариации, играя на разных рисунках и фактурах. Может быть уложена на полы или стены в разных, но всегда эффектных схемах укладки.



FLOOR  
Boost Stone **Smoke** Matte/Matt  
120x120 cm | 47<sup>1</sup>/<sub>4</sub>"x47<sup>1</sup>/<sub>4</sub>"

BATHTUB AREA  
Boost Stone **Mosaico Cube Cold**  
30x30 cm | 11<sup>3</sup>/<sub>4</sub>"x11<sup>3</sup>/<sub>4</sub>"

Boost Stone **Smoke** Matte/Matt  
120x278 cm | 47<sup>1</sup>/<sub>4</sub>"x109<sup>1</sup>/<sub>2</sub>"

Boost **White** Matte/Matt  
120x278 cm | 47<sup>1</sup>/<sub>4</sub>"x109<sup>1</sup>/<sub>2</sub>"

INDEX



OVERVIEW

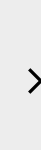

IMAGE GALLERY



- PRIVATE VILLA IN&OUT - Cream, Ivory
- LIVING ROOM IN&OUT - Grey
- STUDIO&TERRACE - Tarmac
- RESIDENTIAL OUTDOOR, KITCHEN
- RESIDENTIAL BATHROOM - White
- RESIDENTIAL BATHROOM - Ivory
- WELLNESS SPA&RELAX - Taupe, Clay
- COMMERCIAL RESTROOM - Smoke
- FASHION SHOWROOM - Ivory

PRODUCT RANGE & TECHNICAL SPECS.



BOOST WORLD



SUSTAINABILITY



THE BENEFITS OF CERAMIC TILES





FLOOR  
 Boost Stone **Smoke** Matte/Matt  
 120x120 cm | 47<sup>1</sup>/<sub>4</sub>"x47<sup>1</sup>/<sub>4</sub>"

Boost Stone **Mosaico Cube Cold**  
 30x30 cm | 11<sup>3</sup>/<sub>4</sub>"x11<sup>3</sup>/<sub>4</sub>"

WALL  
 Boost Stone **Smoke** Matte/Matt  
 120x278 cm | 47<sup>1</sup>/<sub>4</sub>"x109<sup>1</sup>/<sub>2</sub>"

Boost **White** Matte/Matt  
 120x278 cm | 47<sup>1</sup>/<sub>4</sub>"x109<sup>1</sup>/<sub>2</sub>"



INDEX



OVERVIEW



IMAGE GALLERY



- PRIVATE VILLA IN&OUT - Cream, Ivory
- LIVING ROOM IN&OUT - Grey
- STUDIO&TERRACE - Tarmac
- RESIDENTIAL OUTDOOR, KITCHEN
- RESIDENTIAL BATHROOM - White
- RESIDENTIAL BATHROOM - Ivory
- WELLNESS SPA&RELAX - Taupe, Clay
- COMMERCIAL RESTROOM - Smoke
- FASHION SHOWROOM - Ivory

PRODUCT RANGE & TECHNICAL SPECS.



BOOST WORLD



SUSTAINABILITY



THE BENEFITS OF CERAMIC TILES





# Welcoming texture.

The 120x278 format is ideal for cladding walls all the way to the ceiling in a large commercial space and reducing the number of joints. The combination of the stone effect with other surfaces, such as the concrete or marble effect, generates a pleasant contrast of materials and styles.

Il formato 120x278 è ideale per rivestire pareti a tutta altezza in un ampio spazio commerciale e ridurre il numero delle fughe. L'abbinabilità dell'effetto pietra ad altre superfici, come l'effetto cemento o marmo, genera un piacevole contrasto materico e stilistico.

Le format 120x278 est idéal pour couvrir les murs toute hauteur d'un grand espace commercial et réduire le nombre de joints. La combinaison de l'effet pierre avec d'autres surfaces, telles que l'effet béton ou marbre, génère un agréable contraste de matière et de style.

Das Format 120x278 ist ideal, um Wände in einem großen Verkaufslokal raumhoch zu verkleiden und die Anzahl der Fugen zu reduzieren. Die Kombinierbarkeit der Steinoptik mit anderen Oberflächen wie Zement- oder Marmoroptik erzeugt einen ansprechenden stofflich-stilistischen Kontrast.

El tamaño 120x278 es ideal para cubrir paredes de altura completa en un gran espacio comercial y reducir el número de juntas. La posibilidad de combinar el efecto piedra con otras superficies, como el cemento o el mármol, crea un agradable contraste material y estilístico.

Форматом 120x278 можно покрыть стены торгового интерьера на всю высоту с вытекающей из этого минимизацией количества швов. Сочетание фактуры камня с другими рисунками, например, мрамора и цемента, рождает приятный контраст материалов и стилей.



FLOOR  
Boost Stone **Ivory** Matte/Matt  
120x120 cm | 47<sup>1</sup>/<sub>4</sub>"x47<sup>1</sup>/<sub>4</sub>"

WALL  
Boost Stone **Ivory** Matte/Matt  
120x278 cm | 47<sup>1</sup>/<sub>4</sub>"x109<sup>1</sup>/<sub>2</sub>"

INDEX



OVERVIEW



IMAGE GALLERY



- PRIVATE VILLA IN&OUT - Cream, Ivory
- LIVING ROOM IN&OUT - Grey
- STUDIO&TERRACE - Tarmac
- RESIDENTIAL OUTDOOR, KITCHEN
- RESIDENTIAL BATHROOM - White
- RESIDENTIAL BATHROOM - Ivory
- WELLNESS SPA&RELAX - Taupe, Clay
- COMMERCIAL RESTROOM - Smoke
- FASHION SHOWROOM - Ivory**

PRODUCT RANGE & TECHNICAL SPECS.



BOOST WORLD



SUSTAINABILITY



THE BENEFITS OF CERAMIC TILES





The surfaces of Boost Stone are designed to interact with all the products of Boost World, combining the natural vigor of the stone effect with the other inspirations of this cross-cutting project.

Le superfici di Boost Stone sono studiate per dialogare con tutti i prodotti di Boost World, combinando il vigore naturale dell'effetto pietra alle altre ispirazioni di questo progetto trasversale.

Les surfaces de Boost Stone sont conçues pour dialoguer avec tous les produits de Boost World, alliant la vigueur naturelle de l'effet pierre aux autres inspirations de ce projet transversal.

Die Oberflächen von Boost Stone sind dafür konzipiert, mit allen Boost World-Produkten zu dialogieren, so dass sich die natürliche Kraft der Steinoptik mit den anderen Inspirationen dieses breit angelegten Projekts verbindet.

Las superficies de Boost Stone se han creado para dialogar con todos los productos de Boost World, combinando el vigor natural del efecto piedra con las demás inspiraciones de este proyecto transversal.

Плитки Boost Stone спроектированы таким образом, чтобы сочетаться со всеми изделиями линейки Boost World: получается интересный контраст суровой фактуры камня с другими фактурами этого комплексного проекта.



FLOOR  
Boost Stone **Ivory** Matte/Matt  
120x120 cm | 47<sup>1</sup>/<sub>4</sub>"x47<sup>1</sup>/<sub>4</sub>"

WALL  
Boost Stone **Ivory** Matte/Matt  
120x278 cm | 47<sup>1</sup>/<sub>4</sub>"x109<sup>1</sup>/<sub>2</sub>"

Boost Natural **Coral** Matte/Matt  
120x278 cm | 47<sup>1</sup>/<sub>4</sub>"x109<sup>1</sup>/<sub>2</sub>"

SHELVES  
Boost Stone **Ivory** Matte/Matt  
120x278 cm | 47<sup>1</sup>/<sub>4</sub>"x109<sup>1</sup>/<sub>2</sub>"

INDEX



OVERVIEW



IMAGE GALLERY



- PRIVATE VILLA IN&OUT - Cream, Ivory
- LIVING ROOM IN&OUT - Grey
- STUDIO&TERRACE - Tarmac
- RESIDENTIAL OUTDOOR, KITCHEN
- RESIDENTIAL BATHROOM - White
- RESIDENTIAL BATHROOM - Ivory
- WELLNESS SPA&RELAX - Taupe, Clay
- COMMERCIAL RESTROOM - Smoke
- FASHION SHOWROOM - Ivory

PRODUCT RANGE & TECHNICAL SPECS.



BOOST WORLD



SUSTAINABILITY



THE BENEFITS OF CERAMIC TILES







FLOOR  
Boost Stone **Ivory** Matte/Matt  
120x120 cm | 47<sup>1</sup>/<sub>4</sub>"x47<sup>1</sup>/<sub>4</sub>"

Boost Stone **Ivory Mosaico Hex**  
25x28,5 cm | 9<sup>7</sup>/<sub>8</sub>"x11<sup>1</sup>/<sub>4</sub>"

WALL  
Boost Stone **Ivory** Matte/Matt  
120x278 cm | 47<sup>1</sup>/<sub>4</sub>"x109<sup>1</sup>/<sub>2</sub>"

COUNTER  
Marvel Shine **Calacatta Delicato**  
Polished/Lappato  
120x278 cm | 47<sup>1</sup>/<sub>4</sub>"x109<sup>1</sup>/<sub>2</sub>"



INDEX



OVERVIEW



IMAGE GALLERY



- PRIVATE VILLA IN&OUT - Cream, Ivory
- LIVING ROOM IN&OUT - Grey
- STUDIO&TERRACE - Tarmac
- RESIDENTIAL OUTDOOR, KITCHEN
- RESIDENTIAL BATHROOM - White
- RESIDENTIAL BATHROOM - Ivory
- WELLNESS SPA&RELAX - Taupe, Clay
- COMMERCIAL RESTROOM - Smoke
- FASHION SHOWROOM - Ivory

PRODUCT RANGE & TECHNICAL SPECS.



BOOST WORLD



SUSTAINABILITY



THE BENEFITS OF CERAMIC TILES





# Product Range & Technical Specs.

- 114 SENSITECH
- 116 RANGE SUMMARY
- 124 TECHNICAL FEATURES

INDEX



OVERVIEW



IMAGE GALLERY



PRODUCT RANGE & TECHNICAL SPECS.



SENSITECH

RANGE SUMMARY

TECHNICAL FEATURES

BOOST WORLD



SUSTAINABILITY



THE BENEFITS OF CERAMIC TILES



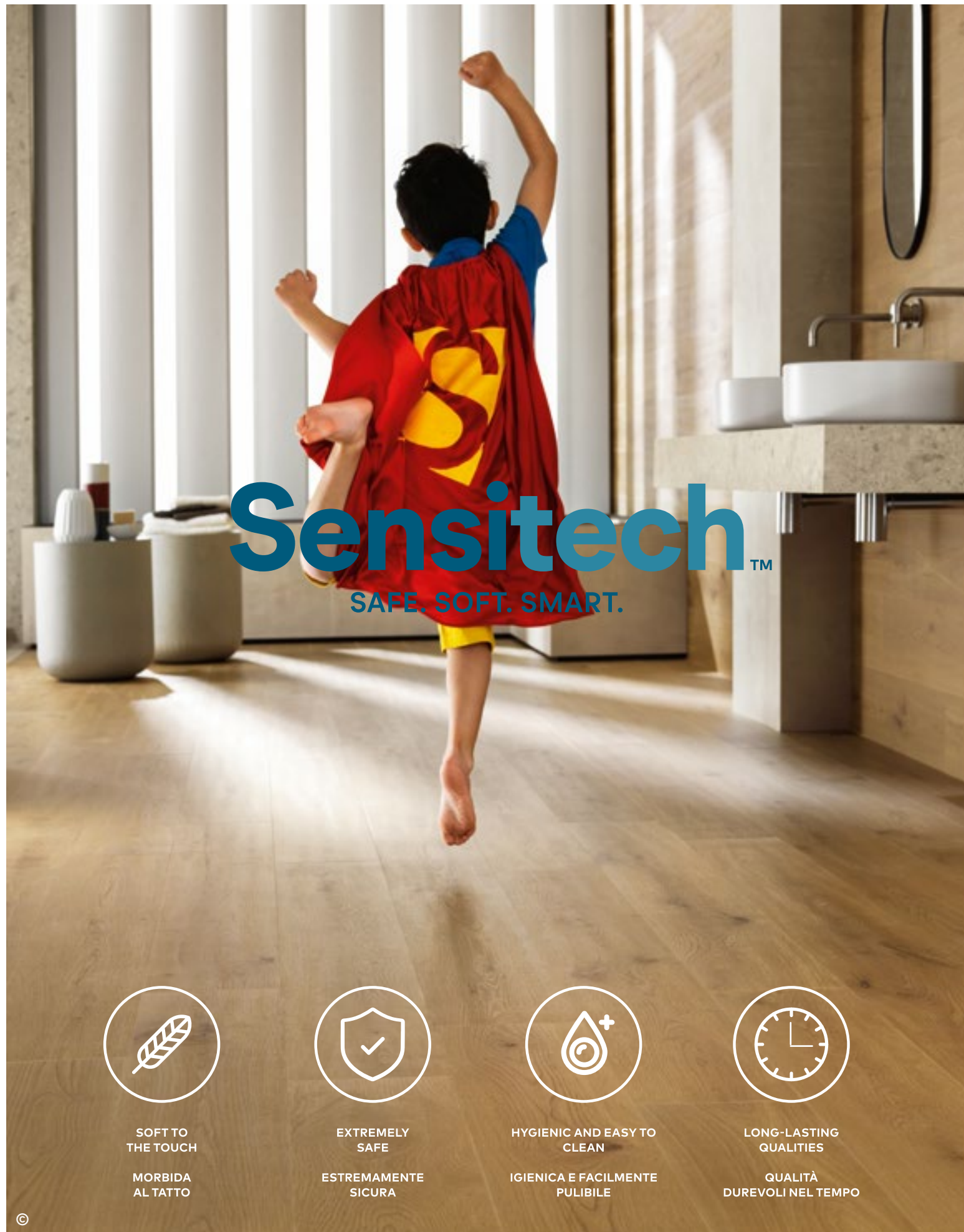

SOFT TO THE TOUCH  
MORBIDA AL TATTO



EXTREMELY SAFE  
ESTREMAMENTE SICURA



HYGIENIC AND EASY TO CLEAN  
IGIENICA E FACILMENTE PULIBILE



LONG-LASTING QUALITIES  
QUALITÀ DUREVOLI NEL TEMPO

# The evolution of ceramic surfaces.

ENJOY THE VIDEO  
EN | IT | FR | DE | RU

DISCOVER MORE  
EN | IT | FR | DE | ES | RU

INDEX

OVERVIEW

IMAGE GALLERY

PRODUCT RANGE & TECHNICAL SPECS.

SENSITECH

RANGE SUMMARY

TECHNICAL FEATURES

BOOST WORLD

SUSTAINABILITY

THE BENEFITS OF CERAMIC TILES

Surface section magnification ( $\mu\text{m}$ )\*  
Ingrandimento di una sezione di superficie ( $\mu\text{m}$ )\*

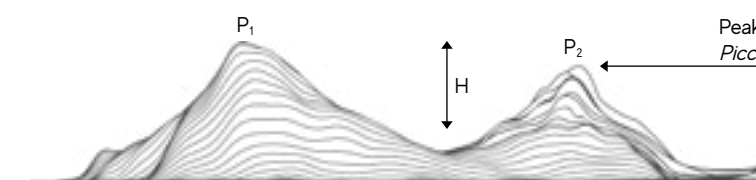

Traditional anti-slip surface  
Superficie anti-slip tradizionale

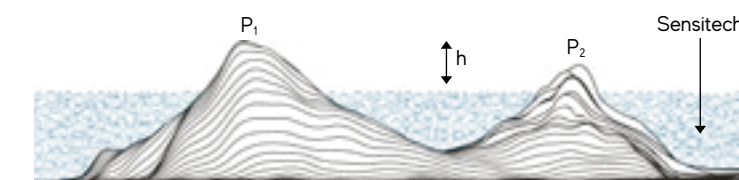

Sensitech surface  
Superficie Sensitech

$P_1 P_2$  Same peaks — same slippery resistance  
*Picchi invariati — uguale resistenza allo scivolamento*

$h < H$  Reduced depth of valleys — smoother surface and greater ease of cleaning  
*Minore profondità degli avvallamenti — percezione di superficie più liscia e maggiore facilità di pulizia*

\* Charts not to scale, for illustrative purposes / *Grafici non in scala, a scopo illustrativo*



# Porcelain tile decors

**Boost Stone White Mosaico Hex**  
25x28,5 cm - 9<sup>7</sup>/<sub>8</sub>"x11<sup>1</sup>/<sub>4</sub>"

**Boost Stone Pearl Mosaico Hex**  
25x28,5 cm - 9<sup>7</sup>/<sub>8</sub>"x11<sup>1</sup>/<sub>4</sub>"

**Boost Stone Grey Mosaico Hex**  
25x28,5 cm - 9<sup>7</sup>/<sub>8</sub>"x11<sup>1</sup>/<sub>4</sub>"

**Boost Stone Smoke Mosaico Hex**  
25x28,5 cm - 9<sup>7</sup>/<sub>8</sub>"x11<sup>1</sup>/<sub>4</sub>"

**Boost Stone Tarmac Mosaico Hex**  
25x28,5 cm - 9<sup>7</sup>/<sub>8</sub>"x11<sup>1</sup>/<sub>4</sub>"

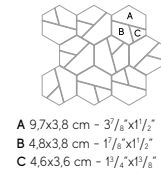

**Boost Stone Ivory Mosaico Hex**  
25x28,5 cm - 9<sup>7</sup>/<sub>8</sub>"x11<sup>1</sup>/<sub>4</sub>"

**Boost Stone Cream Mosaico Hex**  
25x28,5 cm - 9<sup>7</sup>/<sub>8</sub>"x11<sup>1</sup>/<sub>4</sub>"

**Boost Stone Clay Mosaico Hex**  
25x28,5 cm - 9<sup>7</sup>/<sub>8</sub>"x11<sup>1</sup>/<sub>4</sub>"

**Boost Stone Taupe Mosaico Hex**  
25x28,5 cm - 9<sup>7</sup>/<sub>8</sub>"x11<sup>1</sup>/<sub>4</sub>"

**Boost Stone Tobacco Mosaico Hex**  
25x28,5 cm - 9<sup>7</sup>/<sub>8</sub>"x11<sup>1</sup>/<sub>4</sub>"



**Boost Stone White Mosaico Matt**  
30x30 cm - 11<sup>3</sup>/<sub>4</sub>"x11<sup>3</sup>/<sub>4</sub>"

**Boost Stone Pearl Mosaico Matt**  
30x30 cm - 11<sup>3</sup>/<sub>4</sub>"x11<sup>3</sup>/<sub>4</sub>"

**Boost Stone Grey Mosaico Matt**  
30x30 cm - 11<sup>3</sup>/<sub>4</sub>"x11<sup>3</sup>/<sub>4</sub>"

**Boost Stone Smoke Mosaico Matt**  
30x30 cm - 11<sup>3</sup>/<sub>4</sub>"x11<sup>3</sup>/<sub>4</sub>"

**Boost Stone Tarmac Mosaico Matt**  
30x30 cm - 11<sup>3</sup>/<sub>4</sub>"x11<sup>3</sup>/<sub>4</sub>"

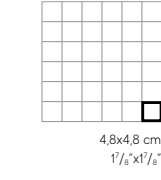

**Boost Stone Ivory Mosaico Matt**  
30x30 cm - 11<sup>3</sup>/<sub>4</sub>"x11<sup>3</sup>/<sub>4</sub>"

**Boost Stone Cream Mosaico Matt**  
30x30 cm - 11<sup>3</sup>/<sub>4</sub>"x11<sup>3</sup>/<sub>4</sub>"

**Boost Stone Clay Mosaico Matt**  
30x30 cm - 11<sup>3</sup>/<sub>4</sub>"x11<sup>3</sup>/<sub>4</sub>"

**Boost Stone Taupe Mosaico Matt**  
30x30 cm - 11<sup>3</sup>/<sub>4</sub>"x11<sup>3</sup>/<sub>4</sub>"

**Boost Stone Tobacco Mosaico Matt**  
30x30 cm - 11<sup>3</sup>/<sub>4</sub>"x11<sup>3</sup>/<sub>4</sub>"

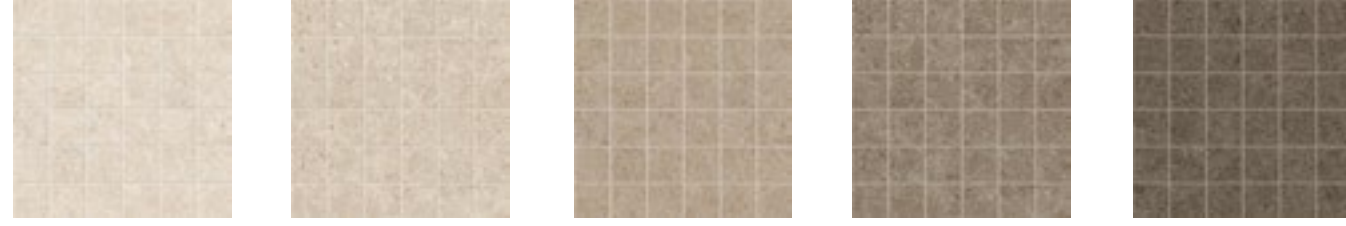

**Boost Stone White Mosaico Brick**  
30x60 cm - 11<sup>3</sup>/<sub>4</sub>"x23<sup>5</sup>/<sub>8</sub>"

**Boost Stone Ivory Mosaico Brick**  
30x60 cm - 11<sup>3</sup>/<sub>4</sub>"x23<sup>5</sup>/<sub>8</sub>"

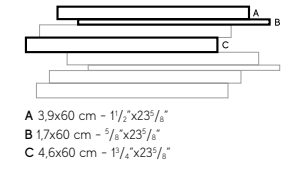

**Boost Stone Pearl Mosaico Brick**  
30x60 cm - 11<sup>3</sup>/<sub>4</sub>"x23<sup>5</sup>/<sub>8</sub>"

**Boost Stone Cream Mosaico Brick**  
30x60 cm - 11<sup>3</sup>/<sub>4</sub>"x23<sup>5</sup>/<sub>8</sub>"



**Boost Stone Grey Mosaico Brick**  
30x60 cm - 11<sup>3</sup>/<sub>4</sub>"x23<sup>5</sup>/<sub>8</sub>"

**Boost Stone Clay Mosaico Brick**  
30x60 cm - 11<sup>3</sup>/<sub>4</sub>"x23<sup>5</sup>/<sub>8</sub>"



**Boost Stone Smoke Mosaico Brick**  
30x60 cm - 11<sup>3</sup>/<sub>4</sub>"x23<sup>5</sup>/<sub>8</sub>"

**Boost Stone Taupe Mosaico Brick**  
30x60 cm - 11<sup>3</sup>/<sub>4</sub>"x23<sup>5</sup>/<sub>8</sub>"



**Boost Stone Tarmac Mosaico Brick**  
30x60 cm - 11<sup>3</sup>/<sub>4</sub>"x23<sup>5</sup>/<sub>8</sub>"

**Boost Stone Tobacco Mosaico Brick**  
30x60 cm - 11<sup>3</sup>/<sub>4</sub>"x23<sup>5</sup>/<sub>8</sub>"



INDEX

OVERVIEW

IMAGE GALLERY

PRODUCT RANGE & TECHNICAL SPECS.

SENSITECH  
RANGE SUMMARY

TECHNICAL FEATURES

BOOST WORLD

SUSTAINABILITY

THE BENEFITS OF CERAMIC TILES

# Porcelain tile decors

**Boost Stone**  
**Mosaico Cube Warm**  
30x30 cm - 11<sup>3</sup>/<sub>4</sub>"x11<sup>3</sup>/<sub>4</sub>"



Warm > Boost Stone Cream, Boost Stone Clay, Boost Stone Ivory, Boost Pro Ivory

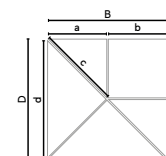

- A 29.8 cm - 11<sup>7</sup>/<sub>8</sub>"
- a 14.6 cm - 5<sup>7</sup>/<sub>8</sub>"
- b 14.8 cm - 5<sup>7</sup>/<sub>8</sub>"
- c 20.8 cm - 8<sup>1</sup>/<sub>4</sub>"
- D 29.8 cm - 11<sup>7</sup>/<sub>8</sub>"
- d 29.5 cm - 11<sup>5</sup>/<sub>8</sub>"

**Boost Stone**  
**Mosaico Cube Cold**  
30x30 cm - 11<sup>3</sup>/<sub>4</sub>"x11<sup>3</sup>/<sub>4</sub>"



Cold > Boost Stone Smoke, Boost Stone Grey, Boost Stone Pearl, Boost Pearl

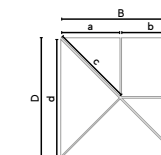

- A 29.8 cm - 11<sup>7</sup>/<sub>8</sub>"
- a 14.6 cm - 5<sup>7</sup>/<sub>8</sub>"
- b 14.8 cm - 5<sup>7</sup>/<sub>8</sub>"
- c 20.8 cm - 8<sup>1</sup>/<sub>4</sub>"
- D 29.8 cm - 11<sup>7</sup>/<sub>8</sub>"
- d 29.5 cm - 11<sup>5</sup>/<sub>8</sub>"

# Laying patterns

**Boost Stone Carpet 01**  
30x30 cm - 11<sup>3</sup>/<sub>4</sub>"x11<sup>3</sup>/<sub>4</sub>"



**Boost Stone Carpet 02**  
30x30 cm - 11<sup>3</sup>/<sub>4</sub>"x11<sup>3</sup>/<sub>4</sub>"



**Boost Stone Fixed**  
30x30 cm - 11<sup>3</sup>/<sub>4</sub>"x11<sup>3</sup>/<sub>4</sub>"



**Boost Stone Random**  
30x30 cm - 11<sup>3</sup>/<sub>4</sub>"x11<sup>3</sup>/<sub>4</sub>"



# Laying patterns

**Boost Stone Carpet 01**  
30x30 cm - 11<sup>3</sup>/<sub>4</sub>"x11<sup>3</sup>/<sub>4</sub>"



**Boost Stone Carpet 02**  
30x30 cm - 11<sup>3</sup>/<sub>4</sub>"x11<sup>3</sup>/<sub>4</sub>"



**Boost Stone Fixed**  
30x30 cm - 11<sup>3</sup>/<sub>4</sub>"x11<sup>3</sup>/<sub>4</sub>"



**Boost Stone Random**  
30x30 cm - 11<sup>3</sup>/<sub>4</sub>"x11<sup>3</sup>/<sub>4</sub>"



INDEX



OVERVIEW



IMAGE GALLERY



PRODUCT RANGE & TECHNICAL SPECS.



SENSITECH

RANGE SUMMARY

TECHNICAL FEATURES

BOOST WORLD



SUSTAINABILITY



THE BENEFITS OF CERAMIC TILES



## Trim tiles

### Indoor trim tiles

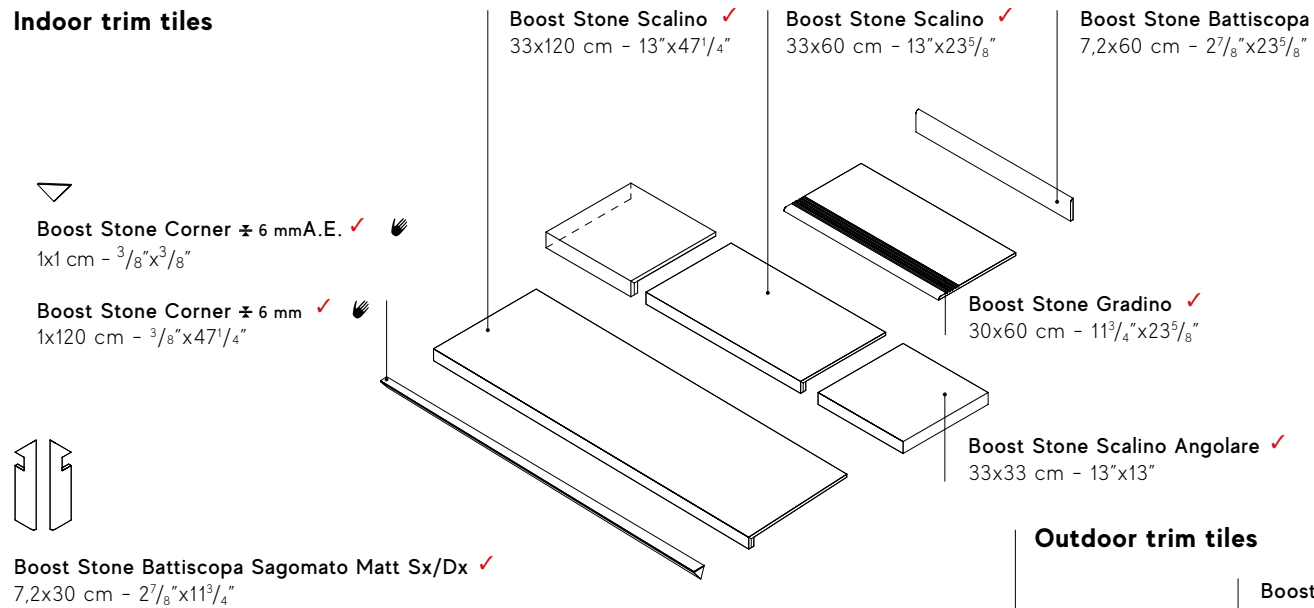

✓ These parts are supplied to order / I pezzi sono disponibili su ordinazione

### Outdoor trim tiles ± 20 mm

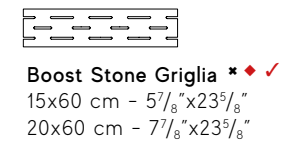
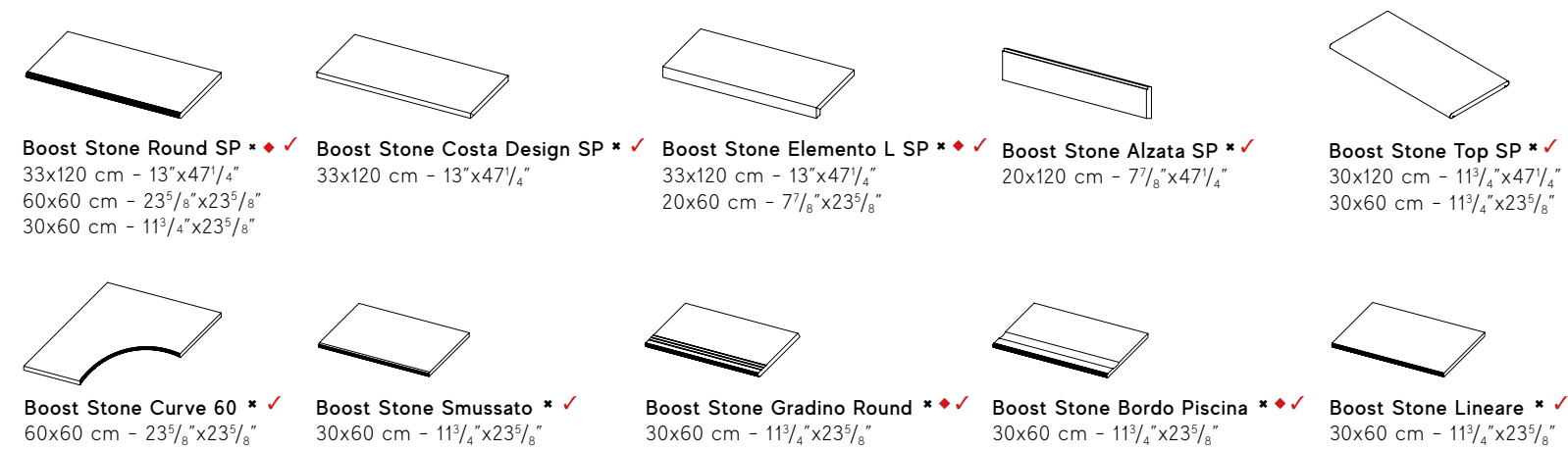

Available in / Disponibile in:

- \* White, Cream, Clay, Grey, Smoke, Tarmac
- ✓ These parts are supplied to order / I pezzi sono disponibili su ordinazione
- ◆ Right-left angular elements are available / Sono disponibili gli elementi angolari dx/sx



INDEX



OVERVIEW



IMAGE GALLERY



PRODUCT RANGE & TECHNICAL SPECS.



SENSITECH

RANGE SUMMARY

TECHNICAL FEATURES

BOOST WORLD



SUSTAINABILITY



THE BENEFITS OF CERAMIC TILES





THANKS TO

**GERVASONI**  
1882  
www.gervasoni1882.it

**ZILIO&C**  
www.zilioaldo.it

**IL GIOVANE NON DOPPIA SPINA**  
www.plinioilgiovane.com

**labottegadicasa**  
www.monicasasiero.it

**IVV**  
Glassmakers  
ITALIA  
www.ivvnet.it

**SOVET**  
ITALIA  
www.sovet.com

**ZAVA**  
www.zavaluce.it

**il giardino di Corten**  
www.ilgiardinodicorten.it

**MEME DESIGN**  
www.memedesign.it

**l'Opificio**  
1998 | TORINO | ITALIA  
www.lopificio.it

**la bottega di casa**  
www.labottegadicasa.com

**WAY**  
www.oway.it

**bosa** ★  
www.bosatrade.com

**Axolight**  
www.axolight.it

**Tisettanta elam**  
www.tisettanta.it



**Porcelain tiles - Rectified monocaliber**

Compliant with standards EN 14411 annex G group B1a  
Compliant with standards ISO 13006 annex G group B1a  
Conforme alla norma EN 14411 Appendice G gruppo B1a  
Conforme alla norma ISO 13006 Appendice G gruppo B1a

**Gres porcellanato - Rettificato monocalibro**

120x278 cm - 47 1/4" x 109 1/2" ± 6 mm  
120x120 cm - 47 1/8" x 47 1/8" ± 9 mm  
60x120 cm - 23 3/8" x 47 1/8" ± 9 mm  
60x60 cm - 23 3/8" x 23 3/8" ± 9 mm  
30x60 cm - 11 7/8" x 23 3/8" ± 9 mm

120x120 cm - 47 1/8" x 47 1/8" ± 20 mm  
60x120 cm - 23 3/8" x 47 1/8" ± 20 mm  
60x60 cm - 23 3/8" x 23 3/8" ± 20 mm

Technical features Caratteristiche tecniche	Test Method Metodo di prova	Requirements for nominal size N / Requisiti per dimensione nominale N			Porcelain tiles				
		7 cm ≤ N < 15 cm		N ≥ 15 cm		Matte   Matte (e) ± 9 mm	Matte ± 9 mm	Grip ± 9 mm	Outdoor ± 20 mm
		MM	(%)	(mm)	(mm)				
Length and width Lunghezza e larghezza	ISO 10545-2	± 0.9 (*) Non-rect. ± 0.4 (*) Rect.	± 0.6 (*) Non-rect. ± 0.3 (*) Rect.	± 2.0 (*) Non-rect. ± 1.0 (*) Rect.	Suitable for Conforme	Suitable for Conforme	Suitable for Conforme	Suitable for Conforme	
		± 0.5 (**)	± 0.5 (**)	± 0.5 (**)	Suitable for Conforme	Suitable for Conforme	Suitable for Conforme	Suitable for Conforme	
		± 0.8 (***) Non-rect. ± 0.4 (***) Rect.	± 0.5 (***) Non-rect. ± 0.3 (***) Rect.	± 1.5 (***) Non-rect. ± 0.8 (***) Rect.	Suitable for Conforme	Suitable for Conforme	Suitable for Conforme	Suitable for Conforme	
Thickness Spessore	ISO 10545-2	± 0.8 (****) Non-rect. ± 0.4 (****) Rect.	± 0.5 (****) Non-rect. ± 0.3 (****) Rect.	± 2.0 (****) Non-rect. ± 1.5 (****) Rect.	Suitable for Conforme	Suitable for Conforme	Suitable for Conforme	Suitable for Conforme	
Straightness of sides Rettilinearità degli spigoli		± 0.8 (****) Non-rect. ± 0.4 (****) Rect.	± 0.5 (****) Non-rect. ± 0.3 (****) Rect.	± 2.0 (****) Non-rect. ± 1.5 (****) Rect.	Suitable for Conforme	Suitable for Conforme	Suitable for Conforme	Suitable for Conforme	
Rectangularity (Measurement only on short edges when L/l ≥ 3) Ortogonalità (Misurazione da condurre solo sui lati corti quando L/l ≥ 3)		± 0.8 (****) Non-rect. ± 0.4 (****) Rect.	± 0.5 (****) Non-rect. ± 0.3 (****) Rect.	± 2.0 (****) Non-rect. ± 1.5 (****) Rect.	Suitable for Conforme	Suitable for Conforme	Suitable for Conforme	Suitable for Conforme	
Surface flatness Planarità	ISO 10545-2	c.c. ± 0.8 Non-rect. c.c. ± 0.6 Rect.	c.c. ± 0.5 Non-rect. c.c. ± 0.4 Rect.	c.c. ± 2.0 Non-rect. c.c. ± 1.8 Rect.	Suitable for Conforme	Suitable for Conforme	Suitable for Conforme	Suitable for Conforme	
		e.c. ± 0.8 Non-rect. e.c. ± 0.6 Rect.	e.c. ± 0.5 Non-rect. e.c. ± 0.4 Rect.	e.c. ± 2.0 Non-rect. e.c. ± 1.8 Rect.					
		w. ± 0.8 Non-rect. w. ± 0.6 Rect.	w. ± 0.5 Non-rect. w. ± 0.4 Rect.	w. ± 2.0 Non-rect. w. ± 1.8 Rect.					
Water absorption (in% by mass) Massa d'acqua assorbita (come % della massa)	ISO 10545-3	E <sub>v</sub> ≤ 0.5% Individual Maximum 0.6% E <sub>v</sub> ≤ 0.5% Valore massimo singolo 0.6%			≤ 0.1 %	≤ 0.1 %	≤ 0.1 %	≤ 0.1 %	
	ASTM C373	Requirement ANSI A1371-2017 Water absorption max ≤ 0.5%			≤ 0.5 %	≤ 0.5 %	≤ 0.5 %	≤ 0.5 %	
Breaking strength Sforzo di rottura	ISO 10545-4	S ≥ 700N (for thickness < 7.5 mm - per spessore < 7.5 mm) S ≥ 1300N (for thickness ≥ 7.5 mm - per spessore ≥ 7.5 mm)			S ≥ 1500 N	S ≥ 1000 N	S ≥ 1500 N	S ≥ 10000 N	
Modulus of rupture Resistenza alla flessione		R ≥ 35 N/mm <sup>2</sup>			R ≥ 40 N/mm <sup>2</sup>	R ≥ 40 N/mm <sup>2</sup>	R ≥ 40 N/mm <sup>2</sup>	R ≥ 45 N/mm <sup>2</sup>	
Bending strength and breaking load Resistenza a flessione e al carico di rottura (4)/(5)	EN 1339 Annex F	-			-	-	-	≥ T11 120x120 60x60 ≥ U4 60x120	
Impact resistance, as coefficient of restitution Resistenza all'impatto, espresso come coefficiente di restituzione	ISO 10545-5	Declared value Valore dichiarato			≥ 0.55	≥ 0.55	≥ 0.55	≥ 0.55	
Mohs hardness Durezza Mohs	EN 101	-			6	6	8	8	
Resistance to deep abrasion of unglazed tiles (removed volume) Resistenza all'abrasione profonda delle piastrelle non smaltate (volume materiale asportato)	ISO 10545-6	≤ 175 mm <sup>3</sup>			≤ 150 mm <sup>3</sup>	≤ 150 mm <sup>3</sup>	≤ 150 mm <sup>3</sup>	≤ 150 mm <sup>3</sup>	
Coefficient of thermal linear expansion Coefficiente di dilatazione termica lineare	ISO 10545-8	Declared value Valore dichiarato			≤ 7MK <sup>-1</sup>	≤ 7MK <sup>-1</sup>	≤ 7MK <sup>-1</sup>	≤ 7MK <sup>-1</sup>	
Thermal shock resistance Resistenza agli sbalzi termici	ISO 10545-9	Pass according to EN ISO 10545-1 Test superato in accordo con ISO 10545-1			Resistant Resiste	Resistant Resiste	Resistant Resiste	Resistant Resiste	
Moisture expansion (in mm/m) Dilatazione all'umidità (in mm/m)	ISO 10545-10	Declared value Valore dichiarato			≤ 0.01% (0.1mm/m)	≤ 0.01% (0.1mm/m)	≤ 0.01% (0.1mm/m)	≤ 0.01% (0.1mm/m)	
Frost resistance Resistenza al gelo	ISO 10545-12	Pass according to EN ISO 10545-1 Test superato in accordo con ISO 10545-1			Resistant Resiste	Resistant Resiste	Resistant Resiste	Resistant Resiste	
Bond strength/adhesion for improved cementitious adhesives Adesione a trazione con adesivi cementizi migliorati	EN 1348	Declared value Valore dichiarato			≥ 1.0 N/mm <sup>2</sup> (Class C2 - EN 12004)	≥ 1.0 N/mm <sup>2</sup> (Class C2 - EN 12004)	≥ 1.0 N/mm <sup>2</sup> (Class C2 - EN 12004)	≥ 1.0 N/mm <sup>2</sup> (Class C2 - EN 12004)	
Reaction to fire Reazione al fuoco	-	Class A1 or A1 <sub>s</sub> Classe A1 oppure A1 <sub>s</sub>			A1 - A1 <sub>s</sub>	A1 - A1 <sub>s</sub>	A1 - A1 <sub>s</sub>	A1 - A1 <sub>s</sub>	
Resistance to household chemicals and swimming pool salts Resistenza ai prodotti chimici di uso domestico e agli additivi per piscina	ISO 10545-13	Minimum Class B Classe minima B			A	A	A	A	
Resistance to low concentrations of acids and alkalis Resistenza a basse concentrazioni di acidi e alcali		Declared Class Classe dichiarata			LA	LA	LA	LA	
Resistance to high concentrations of acids and alkalis Resistenza ad alte concentrazioni di acidi e alcali		Declared Class Classe dichiarata			HA	HA	HA	HA	
Resistance to staining, for unglazed tiles Resistenza alle macchie per piastrelle non smaltate	ISO 10545-14	Declared Class Classe dichiarata			5	5	5	5	
Shod Ramp Test Metodo della rampa "calzato"	EN 16165 ANNEX B (EX DIN 5130)	Declared value Valore dichiarato			R10	R9	R11	R11	
Barefoot Ramp Test Metodo della rampa a piedi nudi	EN 16165 ANNEX A (EX DIN 51097)	Declared value Valore dichiarato			A+B	A	A+B+C	A+B+C	
Pendulum Friction Test Metodo del Pendolo	BS 7976	PTV ≥ 36 classifies the surface as "low slip risk"			≥ 36 Dry ≥ 36 Wet	(●)	≥ 36 Dry ≥ 36 Wet	≥ 36 Dry ≥ 36 Wet	
	AS 4586	Declared Classification of the new pedestrian surface materials according to the Pendulum Test			Class P3	(●●)	Class P4	Class P4	
	UNE-ENV 12633	Declared value Valore dichiarato			Class C2	(●●●)	Class C3	Class C3	
Coefficient of friction (COF) Coefficiente di attrito	B.C.R.A. Rep. CEC/81	D. M. 236/89 del 14/06/89 μ > 0.40 per elemento scivolare cuoio su pavimentazione asciutta μ > 0.40 per elemento scivolare gomma dura su pavimentazione bagnata			> 0.40 Asciutto > 0.40 Bagnato	> 0.40 Asciutto > 0.40 Bagnato	> 0.40 Asciutto > 0.40 Bagnato	> 0.40 Asciutto > 0.40 Bagnato	
Dynamic coefficient of friction (DCOF) Coefficiente di attrito dinamico	ANSI A 326.3	-			wet DCOF ≥ 0.50	wet DCOF ≥ 0.42	wet DCOF ≥ 0.55	wet DCOF ≥ 0.55	

(\*) The permissible deviation, in % or mm, of the average size for each tile (2 or 4 sides) from work size (WS). Deviazione ammissibile, in % oppure mm, della dimensione media di ogni piastrella (2 oppure 4 lati) dalla dimensione di fabbricazione (WS).  
 (\*\*) The permissible deviation, in % or mm, of the average thickness for each tile from the work size thickness (WS). Deviazione ammissibile, in % oppure mm, dello spessore medio di ogni piastrella dallo spessore riportato nella dimensione di fabbricazione (WS).  
 (\*\*\*) The maximum permissible deviation from straightness, in % or mm, related to the corresponding work sizes (WS). Deviazione massima ammissibile di rettilinearità, in % oppure mm, in rapporto alle dimensioni di fabbricazione (WS) corrispondenti.  
 (\*\*\*\*) The maximum permissible deviation from rectangularity, in % or mm, related to the corresponding work sizes (WS). Deviazione massima ammissibile di ortogonalità, in % oppure mm, in rapporto alle dimensioni di fabbricazione (WS) corrispondenti.  
 c.c. The maximum permissible deviation from centre curvature, in % or mm, related to diagonal calculated from the work size (WS). Deviazione massima ammissibile della curvatura del centro, in % oppure mm, in rapporto alla diagonale calcolata secondo le dimensioni di fabbricazione (WS).  
 e.c. The maximum permissible deviation from edge curvature, in % or mm, related to the corresponding work sizes (WS). Deviazione massima ammissibile della curvatura dello spigolo, in % oppure mm, in rapporto alle dimensioni di fabbricazione (WS) corrispondenti.  
 w. The maximum permissible deviation from warpage, in % or mm, related to diagonal calculated from the work sizes (WS). Deviazione massima ammissibile dello svergolamento, in % oppure mm, in rapporto alla diagonale calcolata secondo le dimensioni di fabbricazione (WS).  
 (1) Determination of slip resistance of pedestrian surfaces; it does not cover sports surfaces and road surfaces for vehicles (skid resistance). Determinazione della resistenza allo scivolamento delle superfici pedonabili; non si applica alle pavimentazioni sportive ed alle pavimentazioni stradali veicolari.  
 (2) Anti-slip performance is guaranteed at the time of delivery of the product. Le prestazioni anti-slip vengono garantite al momento della consegna del prodotto.  
 (3) However, tiles with a DCOF of 0.42 or greater are not necessarily suitable for all projects. The specifier shall determine tiles appropriate for specific project conditions, considering by way of example, but not in limitation, type of use, traffic, expected contaminants, expected maintenance, expected wear, and manufacturers guidelines and recommendations.  
 (4) For further details, please refer to outdoor design general catalogue. Per maggiori informazioni riferirsi al catalogo generale Outdoor Design.  
 (5) Only for products with 20 mm thickness. Solo per prodotti a 20mm di spessore.  
 (e) PTV ≥ 36 Wet on demand / su richiesta  
 (●●) P3 on demand / su richiesta  
 (●●●) C2 on demand / su richiesta

Note

For information and details relating to codes, packaging and weight it is recommended to refer to the latest pricelist. - Per le informazioni e i dati relativi a codici, imballaggi e pesi occorre sempre consultare l'ultimo listino aggiornato e in vigore. - Pour toutes informations et renseignements concernant les codes, les emballages et les poids, il y a toujours lieu de consulter le dernier tarif en vigueur et mis à jour. - Für Informationen und Daten die den Code, die Verpackung und das Gewicht betreffen bitte die aktuellste Preisliste zugrunde legen. - Para acceder a la información y a los datos relativos a códigos, embalajes y pesos hay que consultar siempre la última lista de precios actualizada y vigente. - Для информации о кодах, упаковках и весе обращайтесь к последнему действующему прайс-листу.

Colors and optical features of the materials illustrated in this catalogue are to be regarded as mere indications. - I colori e le caratteristiche estetiche dei materiali illustrati nel presente catalogo sono da ritenersi puramente indicativi. - Les coloris et les caractéristiques esthétiques des références illustrées dans le catalogue sont donnés à titre purement indicatif. - Die Farben und die ästhetischen Eigenschaften der in diesem Katalog abgebildeten Produkte sind als reine Richtwerte zu betrachten. - Los colores y las características estéticas de los materiales ilustrados en el presente catálogo deben ser considerados como puramente indicativos. - Цвета и эстетические характеристики описанных в настоящем каталоге материалов являются только ориентировочными.

INDEX

OVERVIEW

IMAGE GALLERY

PRODUCT RANGE & TECHNICAL SPECS.

SENSITECH

RANGE SUMMARY

TECHNICAL FEATURES

BOOST WORLD

SUSTAINABILITY

THE BENEFITS OF CERAMIC TILES





# BOOSTWORLD

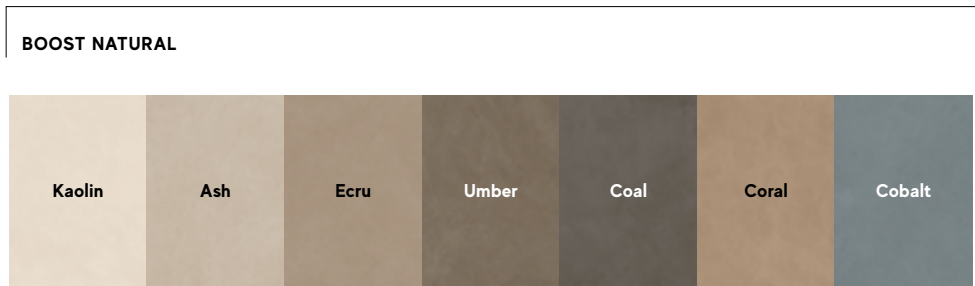

## Porcelain tiles



160x320 cm - 63"x126"	± 6 mm							
160x160 cm - 63"x63"	± 6 mm							
120x278 cm - 47 1/4"x109 1/2"	± 6 mm	Matte	Matte	Matte	Matte	Matte	Matte	Matte
120x240 cm - 47 1/4"x94 1/2"	± 9 mm							
120x120 cm - 47 1/4"x47 1/4"	± 6 mm							
	± 9 mm	Matte (S)	Matte (S)	Matte (S)	Matte (S)	Matte (S)	Matte (S)	Matte (S)
75x150 cm - 29 1/2"x59"	± 9 mm							
60x120 cm - 23 5/8"x47 1/4"	± 9 mm	Matte (S)	Matte (S)	Matte (S)	Matte (S)	Matte (S)	Matte (S)	Matte (S)
75x75 cm - 29 1/2"x29 1/2"	± 9 mm							
37,5x75 cm - 14 3/4"x29 1/2"	± 9 mm							
60x60 cm - 23 5/8"x23 5/8"	± 9 mm	Matte (S)	Matte (S)	Matte (S)	Matte (S)	Matte (S)		
30x60 cm - 11 3/4"x23 5/8"	± 9 mm	Matte (S)	Matte (S)	Matte (S)	Matte (S)	Matte (S)		

### Outdoor and Wet Areas

120x120 cm - 47 1/4"x47 1/4"	± 9 mm	Grip	Grip	Grip	Grip	Grip		
60x120 cm - 23 5/8"x47 1/4"	± 9 mm	Grip	Grip	Grip	Grip	Grip		
30x60 cm - 11 3/4"x23 5/8"	± 9 mm							
120x240 cm - 47 1/4"x94 1/2"	± 20 mm							
120x120 cm - 47 1/4"x47 1/4"	± 20 mm	Outdoor	Outdoor	Outdoor				
60x120 cm - 23 5/8"x47 1/4"	± 20 mm							
90x90 cm - 35 3/8"x35 3/8"	± 20 mm							
60x60 cm - 23 5/8"x23 5/8"	± 20 mm	Outdoor	Outdoor	Outdoor				

### Atlas Plan

162x324 cm - 63 3/4"x127 1/2"	± 12 mm			Hammered				
> Non rectified - non rettificato	± 20 mm							

## Wall tiles



50x120 cm - 19 5/8"x47 1/4"	± 8,5 mm	Matte	Matte	Matte
50x120 cm - 19 5/8"x47 1/4" 3D Brushed	± 8,5 mm	Matte	Matte	Matte
50x120 cm - 19 5/8"x47 1/4" 3D Texture	± 8,5 mm	Matte	Matte	Matte
50x120 cm - 19 5/8"x47 1/4" 3D Wave	± 8,5 mm	Matte	Matte	Matte

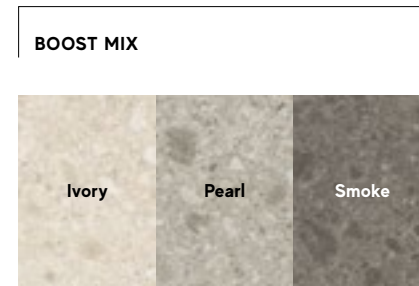

### BOOST MIX

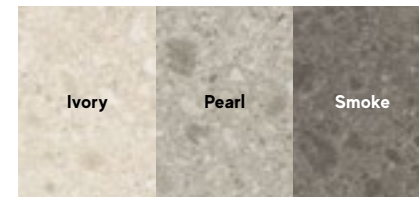

Matte	Matte	Matte
Matte (S)	Matte (S)	Matte (S)
Matte (S)	Matte (S)	Matte (S)
Matte (S)	Matte (S)	Matte (S)
Matte (S)	Matte (S)	Matte (S)

Grip	Grip	Grip
Outdoor	Outdoor	Outdoor
Outdoor	Outdoor	Outdoor
Outdoor	Outdoor	Outdoor

--	--	--



INDEX



OVERVIEW



IMAGE GALLERY



PRODUCT RANGE & TECHNICAL SPECS.



BOOST WORLD



SUSTAINABILITY



THE BENEFITS OF CERAMIC TILES



# Environmental sustainability



## Our certifications:

### Company Azienda



### Product Prodotto



### Product "Declarations" Dichiarazioni di prodotto

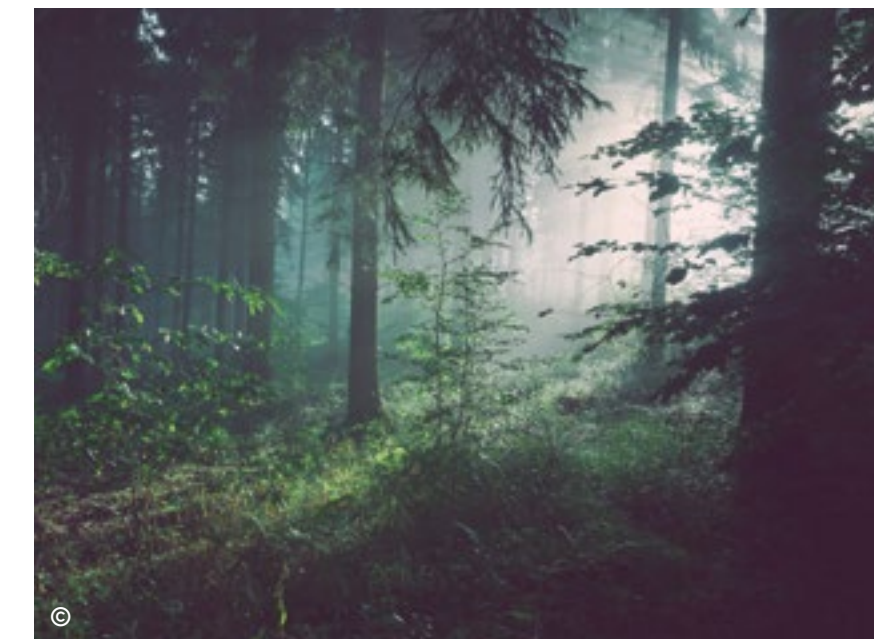
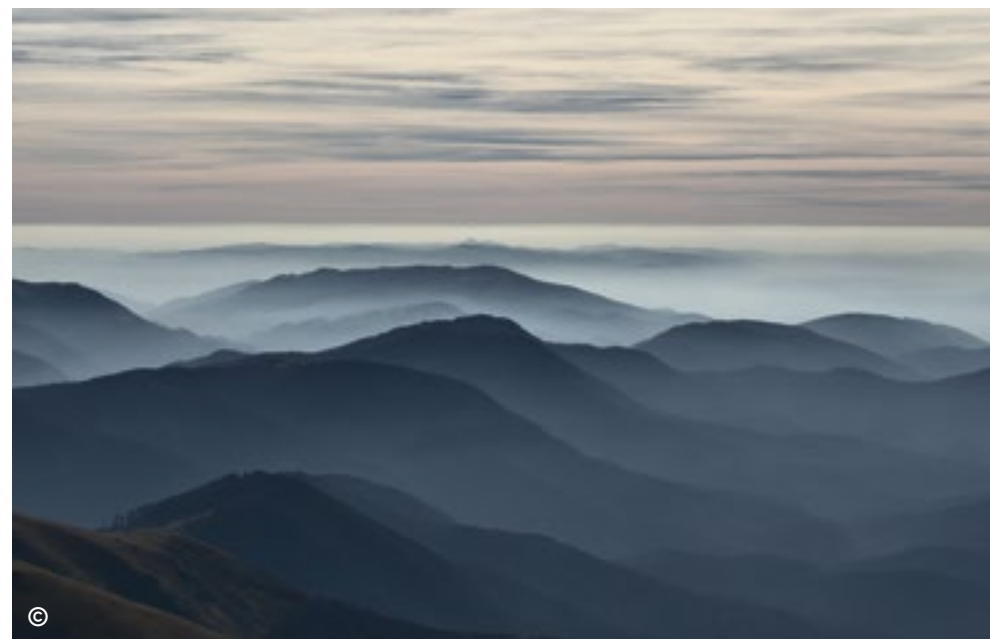

### Energy efficiency

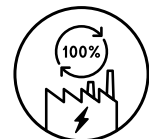

100% autonomous on energy



Hot air heat recovery from kilns and cooling water

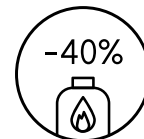

40% savings on natural gas

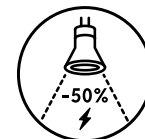

100% LED lighting  
50% ANNUAL SAVINGS in electricity consumption

### Waste management



100% recycled scraps



99% of waste sent for recovery and 25% waste reduction in the last two years

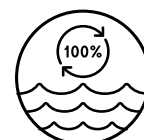

100% recycled industrial water and 27% reduction in water consumption in the last two years

### Environment and health first



Cardboard and other packaging: 100% recycled material

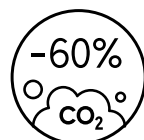

MAV Automatic Vertical Warehouse: 60% CO2 reduction



Complete air filtration

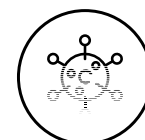

Absence of carcinogenic substances in products

An ecological transition is among the company's industrial priorities. Our plants comply with the most stringent international regulations – fully automated and low-impact – as they are equipped with energy cogeneration systems. A constant commitment to the total reduction of waste and emissions completes the picture of a company oriented towards maximum environmental sustainability.

La transizione ecologica è tra le priorità industriali dell'azienda. I nostri impianti sono conformi alle più stringenti normative internazionali, completamente automatizzati e a basso impatto, in quanto dotati di sistemi di cogenerazione energetica. Il costante impegno per la totale riduzione degli sprechi e delle emissioni completano il quadro di un'azienda orientata alla massima sostenibilità ambientale.

La transition écologique est une des priorités industrielles de l'entreprise. Nos installations sont conformes aux réglementations internationales les plus sévères, entièrement automatisées et à faible impact, car équipées de systèmes de cogénération énergétique. L'engagement constant pour la réduction totale du gaspillage et des émissions complète le tableau d'une entreprise engagée pour une meilleure durabilité environnementale.

Der ökologische Wandel gehört zu den Prioritäten der industriellen Strategie des Unternehmens. Unsere Anlagen entsprechen den strengsten internationalen Richtlinien; sie arbeiten vollautomatisch und umweltschonend, denn sie sind mit Kraft-Wärme-Kopplungssystemen ausgerüstet. Ein weiterer Aspekt dieses Unternehmens, das sich ganz der Erreichung maximaler ökologischer Nachhaltigkeit verschrieben hat, ist sein kontinuierliches Engagement für die völlige Eliminierung von Verschwendung und Emissionen.

La transición ecológica está entre las prioridades industriales de la empresa. Nuestras plantas cumplen las normas internacionales más estrictas, totalmente automatizadas y de bajo impacto, ya que están equipadas con sistemas de cogeneración energética. Los esfuerzos constantes por reducir completamente los residuos y las emisiones completan la imagen de una empresa centrada en la máxima sostenibilidad medioambiental.

Экологический переход – один из основных технологических приоритетов компании. Наши производственные процессы отвечают требованиям строжайших международных стандартов, автоматизированы, оказывают минимальное воздействие на окружающую среду, а кроме того, на заводе работает собственная когенерационная установка. А еще мы принимаем меры по сокращению отходов и выбросов, что является еще одним свидетельством ориентации на экологическую устойчивость.

# Porcelain tiles: a safe choice

INDEX 



OVERVIEW 

## Eco-friendly material

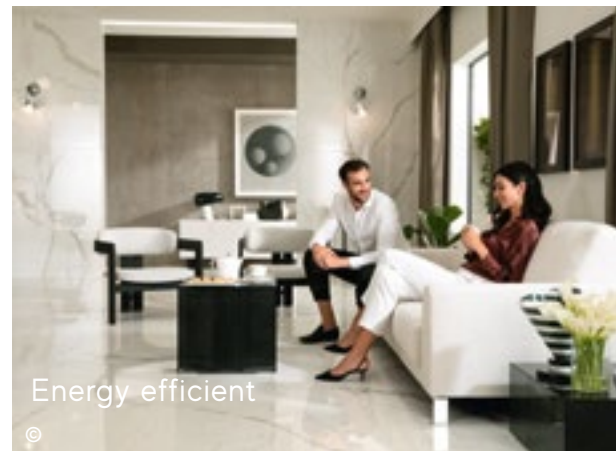

Energy efficient

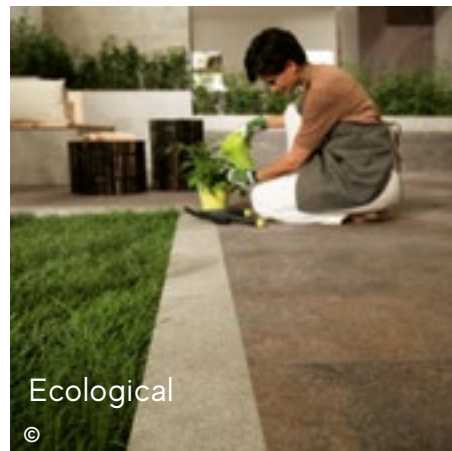

Ecological

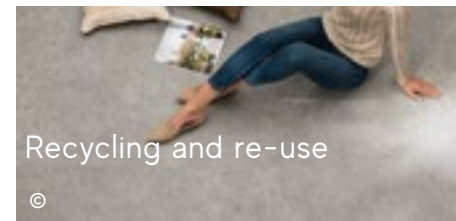

Recycling and re-use

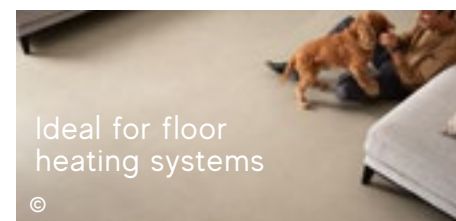

Ideal for floor heating systems

## Safety

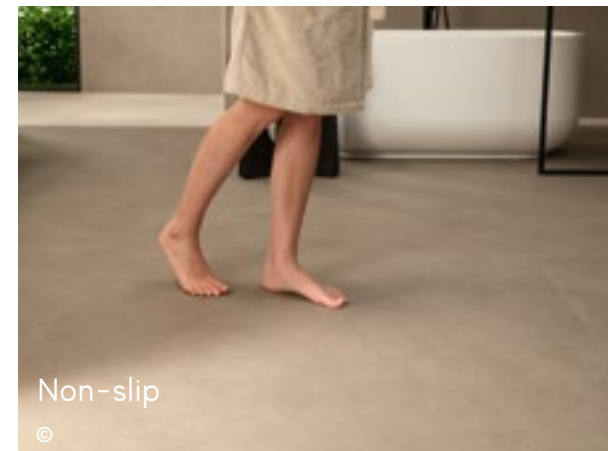

Non-slip

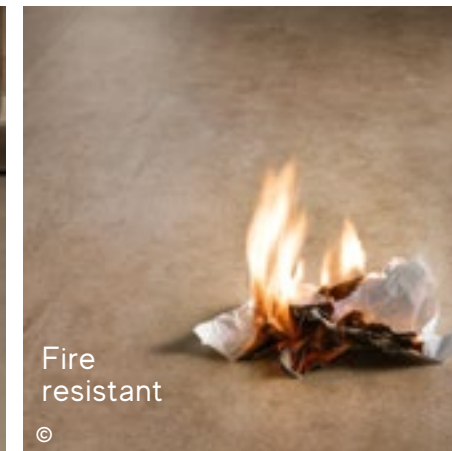

Fire resistant

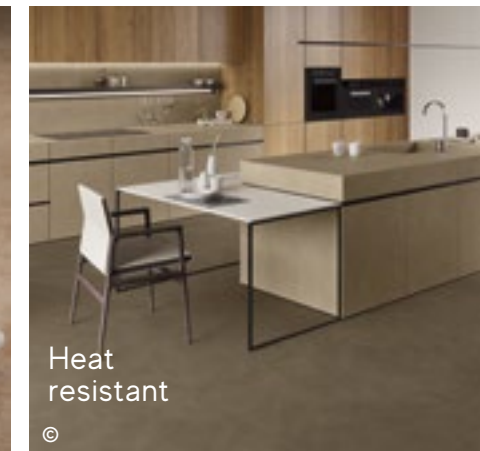

Heat resistant

## Health



Prevent bacterial growth



Zero PVC

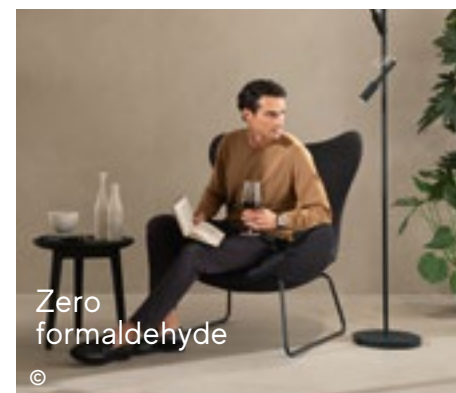

Zero formaldehyde



©



Zero VOCs

## Resistance and duration

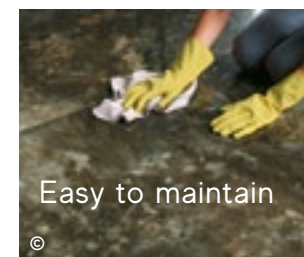

Easy to maintain

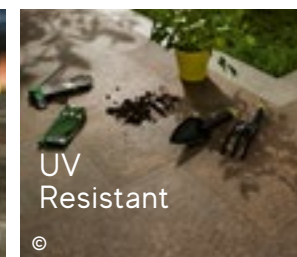

UV Resistant



Stain resistant

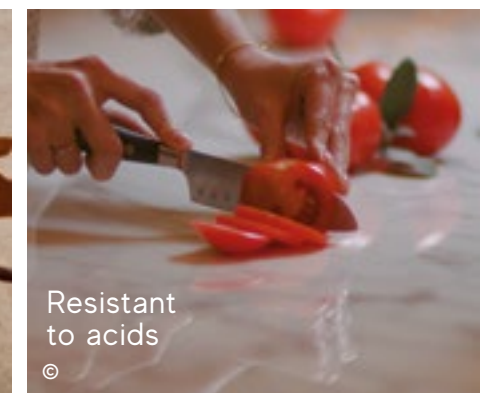

Resistant to acids



Resistant to chemicals

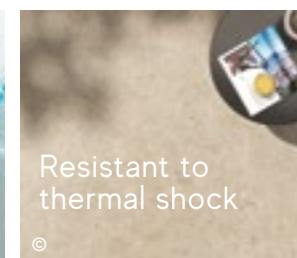

Resistant to thermal shock

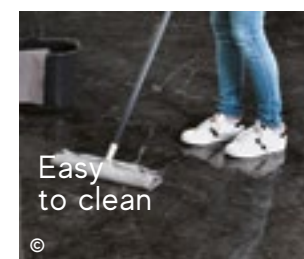

Easy to clean

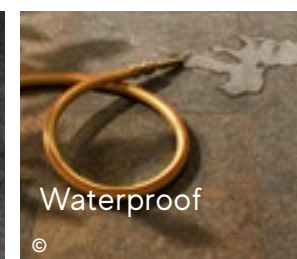

Waterproof

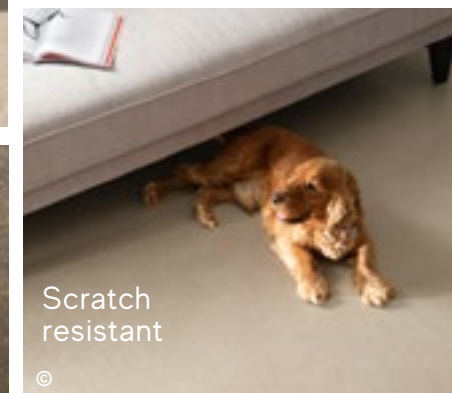



Scratch resistant



Frost resistant

IMAGE GALLERY 

PRODUCT RANGE & TECHNICAL SPECS. 

BOOST WORLD 

SUSTAINABILITY 

THE BENEFITS OF CERAMIC TILES 



## GRANITI VICENTIA BRINGS VALUE TO OUR CUSTOMERS

Graniti Vicentia provides **solutions to create spaces** that support and reflect the individuality, image and brand statement of our customers. We offer a menu of products, services and support to develop your project from the conception to completion.

Our approach is based on a collaborative team of professionals who share their knowledge to work on the project, from concept design, to the technical development of product solutions, through installation.

OUR GOAL IS ALWAYS TO EXCEED THE OWNER'S EXPECTATIONS.

---



**GRANITI VICENTIA**  
GROUP

2135 State Highway 6 South  
Houston, Texas 77077

Phone: +1 713-869-0800

---

[www.granitivicentia.com](http://www.granitivicentia.com)  
[info@granitivicentia.com](mailto:info@granitivicentia.com)



**GRANITI VICENTIA**  
GROUP



**GRANITI VICENTIA**  

---

**GROUP**