

PRISM

PORCELAIN TILE



GRANITI VICENTIA
GROUP



GRANITI VICENTIA BRINGS VALUE TO OUR CUSTOMERS

Graniti Vicentia provides **solutions to create spaces** that support and reflect the individuality, image and brand statement of our customers. We offer a menu of products, services and support to develop your project from the conception to completion.

Our approach is based on a collaborative team of professionals who share their knowledge to work on the project, from concept design, to the technical development of product solutions, through installation.

OUR GOAL IS ALWAYS TO EXCEED THE OWNER'S EXPECTATIONS.

■ SURFACE SOLUTIONS FOR EVERY NEED

GV Surfaces is the division within Graniti Vicentia Group that focuses on surface solutions solutions. We provide innovative solutions that respond to the interior and exterior needs of each of our customers. The flexibility of ceramics allows for each surface to be defined and chosen to create a space with design intent. The portfolio of products offered is the continued effort of GV Surfaces

to keep current. We take great care to select products displaying the **latest trends** in design combined with the **extraordinary quality** and cutting-edge technology of the constant and never-ending research of our vendors. This, along with GV Group's offer of value added fabrication services, provides our customers with **value design**, quality and the performance of surface materials.

QUALITY PRODUCTS FOR UNIQUE PROJECTS.

PORCELAIN AND WALL TILES: A SAFE CHOICE

● **IT DOES NOT BURN**
Non brucia

● **RECYCLABLE**
Riciclabile

● **HYGIENIC**
Igienico

● **VERSATILE**
Versatile

● **IT LOVES THE ENVIRONMENT**
Ama l'ambiente

● **LONG LASTING**
Dura a lungo

● **SAFE**
Sicuro

● **RESISTANT**
Resistente

● **ZERO PVC**
Zero PVC

● **ZERO VOCS**
Zero VOCS

BRUSHSTROKES OF MATTER

With Prism, colors the world of resin effects with 13 soft tones, ideal for spaces with a strong, elegant character, that evokes Italian culture in a contemporary manner. The source of inspiration is hand-troweled resin, reproduced with absolute color depth and graphic detail, boosted by the power of porcelain tiles which have a greater application potential than the original material.

Con Prism, colora il mondo dell'effetto resina con tredici tonalità morbide, ideali per spazi dal carattere deciso ed elegante, capaci di reiventare le suggestioni della cultura italiana in una nuova contemporaneità. L'ispirazione di fondo è la resina spatolata a mano, ricreata con profondità cromatica e dettaglio grafico assoluti, a cui la forza del gres porcellanato conferisce potenzialità applicative superiori rispetto alla materia di ispirazione.

Avec Prism, colore le monde de l'effet résine avec treize teintes douces, idéales pour les espaces au caractère fort et élégant, capables de faire revivre les suggestions de la culture italienne dans une nouvelle contemporanéité. L'inspiration de base est la résine spatulée à la main, recrée avec une profondeur chromatique et des détails graphiques absolus, à laquelle la résistance du grès cérame donne un potentiel d'application supérieur par rapport à la matière d'inspiration.

Mit Prism koloriert das Universum der Harzoptik mit dreizehn weichen Farbtönen. Diese eignen sich hervorragend für Räume mit starkem und elegantem Charakter und sind in der Lage, den Zauber der italienischen Kultur in einer neuen Zeitgenössigkeit wieder aufleben zu lassen. Die grundlegende Inspiration ist das von Hand gespachtelte Harz, das mit vollkommener Farbtiefe und graphischen Details nachgebildet wurde und dem die Stärke des Feinsteinzeugs im Vergleich zum Inspirationsmaterial ein höheres Anwendungspotential verleiht.

Con Prism, colorea el mundo del efecto resina con trece tonalidades suaves, ideales para espacios con un carácter fuerte y elegante, capaces de revivir las sugerencias de la cultura italiana con una nueva contemporaneidad. La inspiración principal es la resina espatulada a mano, recreada con absoluta profundidad cromática y detalle gráfico, a la que la fuerza del gres porcelánico da un potencial de aplicación superior en comparación con el material de inspiración.

В коллекции Prism компания окрашивает фактуру смолы в тринадцать мягких тонов, способных перенести красоту итальянских традиций в новое современное измерение и вдохнуть в пространства красочную элегантность. В основе всего – смола, разглаженная шпателем вручную. Но керамогранит не просто точь-в-точь воспроизводит ее рисунок и глубину цвета, а дополняет их высочайшими техническими качествами, существенно расширяя тем самым потенциал применения.

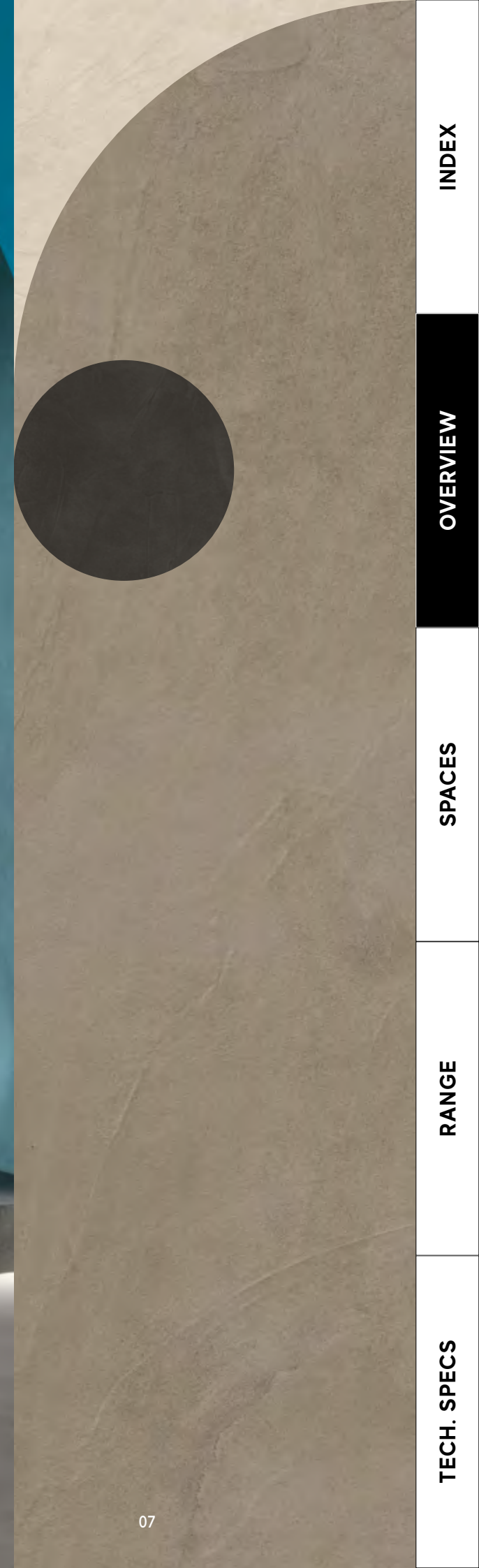

NEUTRAL AND VIVID COLOR

COTTON

CORD

SUEDE

CLOUD

FOG

GRAPHITE

BLOOM

CARAMEL

GRAPE

DUSK

MIDNIGHT

MOSS

EMERALD

Porcelain tiles for Floors and Walls

120x278 cm

Matte

120x120 cm

Matte / Silk

60x120 cm

Matte

60x60 cm

Matte / Silk

30x60 cm

Matte / Silk

Porcelain tiles for Outdoor and Wet Areas

120x120 cm

Grip \pm 9 mm*

Outdoor \pm 20 mm*

80x80 cm

Outdoor \pm 20 mm*

*Available in / Disponibile in:
Suede, Cord, Cloud, Fog

Tiles for Wall Coverings

50x120 cm

Matte

A rich range of sizes allows you to employ the resin effect in any interior design, covering walls and floors in continuity with all the advantages of porcelain floor tiles and the beauty of white body wall tiles.

Una ricca gamma di formati permette di applicare l'effetto resina in ogni progetto di interni, per rivestire pareti e pavimenti in continuità con tutti i vantaggi del gres porcellanato e la bellezza del rivestimento in pasta bianca.

Une ample gamme de formats permet d'appliquer l'effet de résine dans chaque projet d'intérieur, de revêtir les murs et les sols en continuité avec tous les avantages du grès cérame et la beauté du revêtement en pâte blanche.

Eine große Auswahl an Formaten ermöglicht die Anwendung der Harzoptik bei jedem Raumgestaltungsprojekt, um Wände und Fußböden durchgehend mit allen Vorteilen des Feinsteinzeugs und der Schönheit der Weißscherben zu verkleiden.

Una amplia gama de formatos permite aplicar el efecto resina en cada proyecto de interiores, para revestir paredes y pavimentos en continuidad con todas las ventajas del gres porcelánico y la belleza de los revestimientos de pasta blanca.

Богатая гамма форматов дает возможность украсить эффектом смолы полы и стены любого интерьера, обеспечив покрытия все эстетические и эксплуатационные преимущества керамогранита и настенной плитки из белой глины.

SOFT RESIN INSPIRATION

Prism's porcelain floor tiles and wall tiles recreate the three-dimensional effect of hand troweling thanks to a harmonious graphic that reproduces the uneven color of the original material.

Le superfici in gres porcellanato e i rivestimenti di Prism ricreano l'effetto tridimensionale della lavorazione manuale a spatola grazie a una grafica armonica che riproduce la disomogeneità cromatica della materia di riferimento.

Les surfaces en grès cérame et les revêtements de Prism recréent l'effet tridimensionnel du travail manuel à la spatule grâce à une conception graphique harmonieuse qui reproduit l'inhomogénéité chromatique de la matière de référence.

Die Oberflächen aus Feinsteinzeug und die Verkleidungen von Prism imitieren anhand einer harmonischen grafischen Gestaltung, die die farblichen Uneinheitlichkeit der Bezugsmaterie wiedergibt, die dreidimensionale Wirkung der Spachtelung von Hand.

Las superficies en gres porcelánico y los revestimientos de Prism recrean el efecto tridimensional de la elaboración manual con espátula gracias a un diseño gráfico armonioso que reproduce la dishomogeneidad cromática del material de referencia.

Керамогранит и настенная плитка коллекции Prism имеют такой же рельеф и такую же неравномерность цвета, как и смола, разглаженная шпателем вручную.



— MATTE
FINISH —

SILK
FINISH



SMOOTH TACTILE SENSATION

With a velvet touch accompanied by a delicate reflection of the light, the 120x120 cm format is also available in a Silk finish for a resin effect that is even more realistic.

Con un effetto vellutato al tatto che si accompagna a una delicata riflessione della luce, il formato 120x120 cm è disponibile anche in finitura Silk, per un effetto resina ancora più fedele alla realtà.

Avec un effet velouté au toucher qui s'accompagne d'une délicate réflexion de la lumière, le format 120x120 cm est également disponible en finition Silk, pour un effet de résine encore plus fidèle à la réalité.

Das Format 120x120 cm ist auch in der Oberflächenausführung Silk mit einem samtigen, von einer zarten Reflexion des Lichtes begleiteten Griffeffekt erhältlich und gewährleistet eine noch realitätsgetreuere Harzoptik.

Con un efecto aterciopelado al tacto que va acompañado por una delicada reflexión de la luz, el formato 120x120 cm también está disponible en acabado Silk, para un efecto de resina aún más fiel a la realidad.

Формат 120x120 см доступен также в варианте поверхности Silk с приятной бархатистостью на ощупь и очень мягким отражением света. Эффект смолы в этом случае выглядит еще реалистичнее.

PERFECT DESIGN CONTINUITY

The modularity of the surfaces is enriched by the 50x120 cm wall tile format, which can be combined with 120x120 cm and 60x120 cm porcelain floor tiles for designer spaces where color and matter coexist in perfect harmony.

La modularità delle superfici si arricchisce del formato da rivestimento 50x120 cm, abbinabile al pavimento in gres porcellanato 120x120 cm e 60x120 cm per spazi di design, dove il colore e la materia coesistono in una sintesi perfetta.

La modularité des surfaces est renforcée par le format de revêtement mural de 50x120 cm et de 60x120 cm pour les espaces de design, où la couleur et la matière coexistent dans une parfaite synthèse.

Die Modularität der Oberflächen wird durch das Wandfliesenformat 50x120 cm verstärkt, das mit dem Feinsteinzeugboden 120x120 cm und 60x120 cm kombiniert werden kann. Für Designräume, in denen Farbe und Materie in einer perfekten Verbindung nebeneinander bestehen.

La modularidad de las superficies se enriquece con el formato de revestimiento 50x120 cm, que puede combinarse con el pavimento de gres porcelánico 120x120 y 60x120 cm para espacios de diseño, donde el color y la materia coexisten en perfecta síntesis.

Модульные форматы пополняются новым настенным 50x120 см, который сочетается с напольным 120x120 см и 60x120 см. Это великолепное решение для стильных пространств, в которых цвет и материал будут сосуществовать в идеальном симбиозе.

WALL TILES

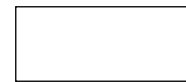

50x120 cm
Matte

PORCELAIN TILES

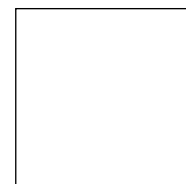

120x120 cm
Matte / Silk



60x120 cm
Matte



INFINITE COMBINATIONS

SUGGESTED COMBINATIONS P.88 >



All Prism surfaces can be mixed and matched to make color combinations with a strong personality, creating original palettes with a refined flavor. Cool shades interact in bright, sophisticated environments, while warmer shades convey sensations of comfort and warmth. The various shades allow both simple combinations of three different colors and bolder contrasts with four shades.

Tutte le superfici di Prism possono essere accostate tra loro in combinazioni cromatiche di forte personalità, per dare vita ad abbinamenti originali e dal sapore ricercato. Le nuance dai toni freddi dialogano tra loro in ambienti luminosi e sofisticati, mentre le sfumature più calde trasmettono sensazioni di comfort e calore. Le varie tonalità consentono sia semplici abbinamenti a tre colori sia contrasti più audaci a quattro tonalità.

Toutes les surfaces de Prism peuvent être combinées entre elles dans des combinaisons de couleurs à forte personnalité, pour créer des combinaisons originales au goût raffiné. Les tons froids dialoguent entre eux dans des environnements lumineux et sophistiqués, tandis que les tons plus chauds transmettent des sensations de confort et de chaleur. Les différentes nuances permettent aussi bien de simples combinaisons de trois couleurs que des contrastes plus audacieux de quatre tons.

Alle Oberflächenausführungen von Prism können in stark charakteristischen Farbkombinationen zusammengestellt werden, um originelle und raffinierte Verbindungen zu kreieren. Die kalten Farbtöne dialogisieren in hellen und raffinierten Umgebungen miteinander, während die wärmeren Farbnuancen ein Gefühl der Behaglichkeit und Wärme vermitteln. Die verschiedenen Farbtöne ermöglichen sowohl einfache Dreifarbkombinationen als auch gewagtere Vierfarbkontraste.

Todas las superficies de Prism pueden unirse en combinaciones cromáticas con una fuerte personalidad, para dar vida a refinadas creaciones originales. Los matices de tonos más fríos dialogan entre sí en ambientes luminosos y sofisticados, mientras que los matices más cálidos transmiten sensaciones de confort y calidez. Las diversas tonalidades permiten tanto combinaciones simples tricolores como contrastes más audaces con cuatro tonalidades.

Все цвета коллекции Prism сочетаются между собой, и любое их соседство выглядит гармонично, оригинально, изысканно. Холодные тона вместе создают в интерьере яркую и утонченную обстановку, теплые дарят ощущение мягкого уюта. Из разных элементов палитры можно составлять простые трехцветные сочетания или более смелые четырехцветные контрасты.

DARE WITH DECORATIONS

The range of decorations is complete both in style and inspiration and also available in large formats. The geometric shapes and colors of the mosaics and decorations multiply the possibilities for customizing any environment. The Gradient and Brush decorations are available in large 120x278 cm porcelain tiles and 50x120 cm wall tiles.

Il corredo decorativo è completo per stile e ispirazione e disponibile anche in grande formato. Le linee geometriche e le policromie di mosaici e decori moltiplicano le possibilità di personalizzazione di ogni ambiente. Il decoro Gradient e il decoro Brush sono disponibili coordinati nel grande formato 120x278 cm in gres porcellanato e nel formato 50x120 cm da rivestimento.

L'ensemble décoratif est complet dans son style et son inspiration et est également disponible en grand format. Les lignes géométriques et les polychromies des mosaïques et des décorations multiplient les possibilités de personnalisation de chaque pièce. Les décorations Gradient et Brush sont disponibles et coordonnés dans le grand format de grès cérame 120x278 cm et dans le format de dalles murales 50x120 cm.

Die dekorative Ausstattung ist vollständig in Stil und Inspiration und auch im großen Format erhältlich. Die geometrischen Linien und die Vielfarbigkeit der Mosaiken und Dekore vermehren die Möglichkeiten der individuellen Gestaltung einer jeden Umgebung. Das Dekor Gradient und das Dekor Brush sind abgestimmt im großen Feinsteinzeugformat 120x278 cm und im Wandfliesenformat 50x120 cm erhältlich.

Conjunto decorativo completo en estilo e inspiración, también está disponible en formato grande. Las líneas geométricas, los mosaicos policromos y las decoraciones multiplican las posibilidades de personalizar cada ambiente. La decoración Gradient y la decoración Brush están disponibles combinadas en el gran formato 120x278 cm en gres porcelánico y en formato 50x120 cm para revestimientos.

Декоративные элементы разных стилей и рисунков доступны также в большом формате. Геометрические узоры и многоцветность мозаики существенно расширяют возможности индивидуализации помещений. Декоры Gradient и Brush доступны во взаимосочетающихся вариантах в большом керамогранитном формате 120x278 см и в настенном формате 50x120 см.



INDEX

OVERVIEW

SPACES

RANGE

TECH. SPECS



GRAPE

CARAMEL

CLOUD

MOSS

MIDNIGHT

DUSK

COTTON

— Prism

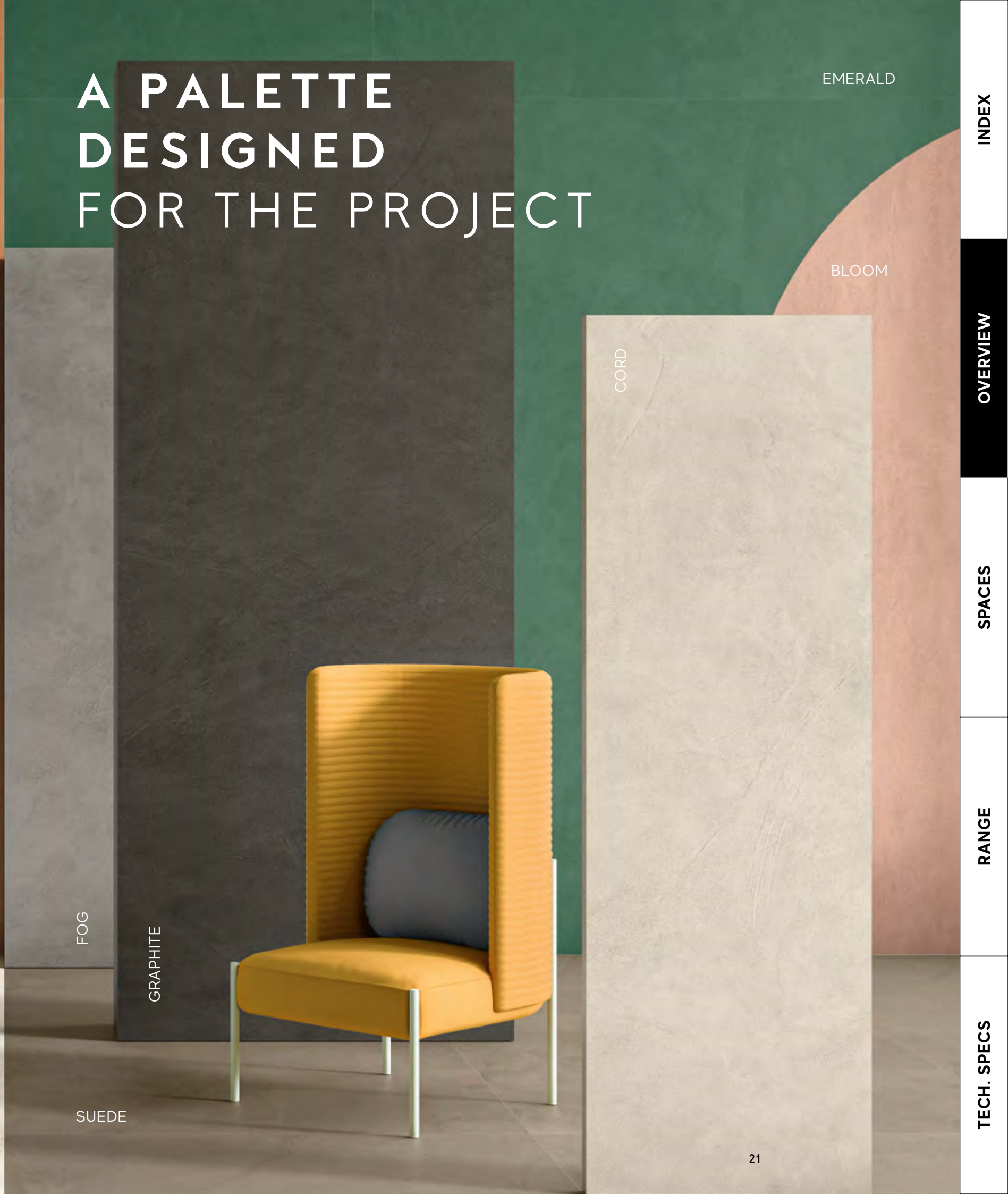

EMERALD

BLOOM

CORD

A PALETTE DESIGNED FOR THE PROJECT

FOG

GRAPHITE

SUEDE

RESIDENTIAL & COMMERCIAL SPACES

Living Room ²⁴

Concept Store ³⁶

Living Villa ⁴²

Restaurant ⁴⁸

Home Spa ⁵²

Outdoor Villa ⁸⁴



BATHROOMS & WELLNESS AREAS

Home Bathroom ⁵⁸

Private Bathroom ⁶⁸

Wellness Room ⁷⁶

TIMELESS DREAM



atlas concorde

LIVING ROOM

INDEX

OVERVIEW

SPACES

RANGE

TECH. SPECS

The velvety appearance of the Silk finish is accompanied by a reduced reflection of light, for an even more realistic resin effect. The 120x278 cm slabs cover the walls seamlessly from floor to ceiling.

L'aspetto vellutato della finitura Silk si accompagna a una ridotta riflessione della luce, per un effetto resina ancora più realistico. Le lastre in 120x278 cm permettono di rivestire le pareti senza soluzione di continuità tra il pavimento e il soffitto.

L'aspect velouté de la finition Silk est accompagné d'une réduction de la réflexion de la lumière pour un effet de résine encore plus réaliste. Les dalles de 120x278 cm permettent de recouvrir les murs de façon homogène entre le sol et le plafond.

Die samtige Optik der Oberflächenausführung Silk wird von einer reduzierten Lichtreflexion für eine noch realistischere Harzoptik begleitet. Die Platten im Format 120x278 cm ermöglichen eine durchgehende Verkleidung der Wände vom Boden bis zur Decke.

El aspecto aterciopelado del acabado Silk va acompañado de una reducida reflexión de la luz para un efecto resina aún más realista. Las placas de 120x278 cm permiten revestir paredes con absoluta continuidad entre el pavimento y el techo.

Бархатистый вид поверхности Silk сопровождается мягким отражением света, что делает эффект смолы необыкновенно реалистичным. Плитами 120x278 см можно цельно покрывать стены снизу доверху без горизонтальных швов.



atlas concorde

The earthy appeal of hand-troweled resin is brought to life in the surface of Prism thanks to the extreme realism of the graphics.

La matericità della resina spatolata a mano rivive nelle superfici di Prism grazie all'estremo realismo delle grafiche.

L'effet-matière de la résine spatulée à la main revit dans les surfaces de Prism grâce à l'extrême réalisme du graphisme.

Die Materialität des von Hand gespachtelten Harzes erwacht dank des extremen Realismus der Grafiken auf den Oberflächen von Prism zu neuem Leben.

La materialidad de la resina espatulada a mano revive en las superficies de Prism gracias al extremo realismo de sus gráficos.

Приятная фактурность разглаженной шпателем смолы воспроизведена в плитке Prism с изумительным реализмом.

atlas concorde





LIFE IN COLOR



THE INTERLOCKING SINUOUS LINES OF MOSAICO BEAD CREATE A DECORATION OF ARCHES THAT ALLOWS CUSTOMIZING ENVIRONMENTS WITH AN ATTRACTIVE, UNOBTRUSIVE PATTERN.

DIE VERWEBUNG DER GESCHWUNGENEN LINIEN DES MOSAICO BEAD SCHAFFT EIN BOGENDEKOR, DAS DIE INDIVIDUELLE GESTALTUNG DER RÄUME MIT EINEM ANSPRECHENDEN UND NICHT INVASIVEN MUSTER GEWÄHRT.

GLI INCASTRI DELLE LINEE SINUOSE DEL MOSAICO BEAD CREANO UN DECORO DI ARCHI CHE PERMETTE DI PERSONALIZZARE GLI AMBIENTI CON UN MOTIVO ACCATTIVANTE E NON INVADENTE.

EL ENTRELAZADO DE LAS LINEAS SINUOSAS DEL MOSAICO BEAD CREA UNA DECORACIÓN DE ARCOS QUE PERMITE PERSONALIZAR LOS AMBIENTES CON UN PATRÓN ATRACTIVO Y NO INVASIVO.

LES ENTRELACEMENTS DES LIGNES SINUEUSES DU MOSAICO BEAD CRÉENT UNE DÉCORATION D'ARCS QUI PERMET DE PERSONNALISER LES PIÈCES AVEC UN MOTIF ATTRAYANT ET NON INVASIF.

СПЛЕТЕНИЕ ИЗВИЛИСТЫХ ЛИНИЙ МОЗАИКИ BEAD ОБРАЗУЕТ ОРИГИНАЛЬНЫЙ АРОЧНЫЙ УЗОР, КОТОРЫЙ ДЕКОРИРУЕТ ИНТЕРЬЕР ЭЛЕГАНТНО И В ТО ЖЕ ВРЕМЯ НЕБРОСКО.



atlas concorde

BAUHAUS



atlas concorde



atlas concorde

DISPLAYED SURFACES

PORCELAIN TILES

Dusk
Matte/Matt
120x278 cm | 47¹/₄"x109¹/₂"

Graphite
Matte/Matt
60x120 cm | 23⁵/₈"x47¹/₄"

Cotton
Matte/Matt
60x120 cm | 23⁵/₈"x47¹/₄"

Cloud
Silk/Silk
120x120 cm | 47¹/₄"x47¹/₄"

WALL TILE DECORS

Midnight
Mosaico Bead
29,7x29,6 cm - 11⁵/₈"x11⁵/₈"

THE 13 SHADES OF THE PRISM RANGE CAN BE COMBINED WITH EACH OTHER, IN MATCHING TONES OR IN COLOR GRADIENTS.

LE TREDICI TONALITÀ DELLA GAMMA PRISM POSSONO ESSERE COMBINATE TRA LORO TONO SU TONO O IN GRADAZIONE CROMATICA.

LES TREIZE NUANCES DE LA GAMME PRISM PEUVENT ÊTRE COMBINÉES TON SUR TON OU EN DÉGRADÉ DE COULEURS.

DIE DREIZEHN FARBTÖNE DES SORTIMENTS PRISM KÖNNEN TON IN TON ODER IN FARBABSTUFUNGEN MITEINANDER KOMBINIERT WERDEN.

LOS TRECE TONOS DE LA GAMA PRISM PUEDEN COMBINARSE TONO SOBRE TONO O EN GRADACIÓN DE COLOR.

ТРИНАДЦАТЬ ЦВЕТОВ ГАММЫ PRISM МОЖНО СКЛАДЫВАТЬ КАК В ОДНОЦВЕТНЫЕ, ТАК И В МНОГОЦВЕТНЫЕ СОЧЕТАНИЯ.



atlas concorde

THE COMFORT OF COLORS

atlas concorde

CONCEPT STORE

The modularity of 120x278 cm porcelain wall tiles with 120x120 cm floor tiles ensures continuity of installation and design uniformity. The resin-effect flooring combines the personality of the original material with the strength of porcelain tiles.

La modularità del rivestimento 120x278 cm in gres porcellanato con il formato 120x120 cm a pavimento assicura continuità di posa e omogeneità progettuale. La pavimentazione effetto resina unisce la personalità della materia di riferimento alla resistenza del gres porcellanato.

La modularité des dalles en grès cérame de 120x278 cm avec le format 120x120 cm au sol assure la continuité de la pose et l'uniformité du design. Le revêtement de sol à effet résine combine la personnalité de la matière de référence avec la résistance du grès cérame.

Die Modularität der Feinsteinzeug-Wandverkleidung im Format 120x278cm mit dem Format 120x120cm der Bodenfliesen gewährleistet eine kontinuierliche Verlegung sowie die Homogenität des Designs. Die Bodenfliese mit Harzoptik verbindet den Charakter der Bezugsmaterie mit der Widerstandsfähigkeit des Feinsteinzeugs.

La modularidad del revestimiento 120x278 cm en gres porcelánico con el formato 120x120 cm en pavimento asegura continuidad de colocación y uniformidad del diseño. El pavimento efecto resina combina la personalidad del material de referencia con la resistencia del gres porcelánico.

Размерная сочетаемость настенного керамогранитного формата 120x278 с напольным 120x120 см придает интерьеру стиливую цельность. Напольная плитка соединяет приятную мягкость эффекта смолы со стойкостью керамогранита.

INDEX

OVERVIEW

SPACES

RANGE

TECH. SPECS



THE MATTE R10 FINISH IS SUITABLE FOR COMMERCIAL APPLICATIONS AND IS AVAILABLE IN SIZES 120x120 cm, 60x120 cm, 60x60 cm, AND 30x60 cm.

LA FINITURA MATTE R10 È ADATTA PER APPLICAZIONI IN AMBIENTI COMMERCIALI ED È DISPONIBILE NEI FORMATI 120x120 cm, 60x120 cm, 60x60 cm E 30x60 cm.

LA FINITION MATTE R10 EST ADAPTÉE AUX APPLICATIONS DANS LES ENVIRONNEMENTS COMMERCIAUX ET EST DISPONIBLE EN 120x120 cm, 60x120 cm, 60x60 cm ET 30x60 cm.

DIE OBERFLÄCHENAUSFÜHRUNG MATTE R10 EIGNET SICH FÜR ANWENDUNGEN AUF GEWERBEFLÄCHEN UND IST IN DEN FORMATEN 120x120 cm, 60x120 cm, 60x60 cm UND 30x60 cm ERHÄLTlich.

EL ACABADO MATT R10 ES ADECUADO PARA APLICACIONES EN AMBIENTES COMERCIALES Y ESTÁ DISPONIBLE EN LOS FORMATOS 120x120 cm, 60x120 cm, 60x60 cm Y 30x60 cm.

МАТОВАЯ ПОВЕРХНОСТЬ MATTE R10 ПОДХОДИТ ДЛЯ КОММЕРЧЕСКИХ ПРОСТРАНСТВ И ДОСТУПНА В ФОРМАТАХ 120x120 см, 60x120 см, 60x60 см И 30x60 см.



**WARM
EMBRACE**



DISPLAYED SURFACES

PORCELAIN TILES

Bloom Matte/Matt 120x278 cm 47 1/4" x 109 1/2"	Suede Matte/Matt 120x278 cm 47 1/4" x 109 1/2"
Caramel Matte/Matt 120x278 cm 47 1/4" x 109 1/2"	Cotton Matte/Matt 120x120 cm 47 1/4" x 47 1/4"
Cotton Matte/Matt 120x278 cm 47 1/4" x 109 1/2"	Suede Matte/Matt 120x120 cm 47 1/4" x 47 1/4"



ELEGANT MATCHES



LIVING VILLA

The modularity of the collection allows combining different sizes depending on the area to be decorated. The neutral shade of the 120x120 cm floor tiles is a perfect foundation to combine with delicate tones in a 60x120 cm format and large colored slabs measuring 120x278 cm. The 120x120 cm format is available in Silk and Matte finishes.

La modularità della collezione consente di accostare formati diversi in funzione dell'area da rivestire. La tonalità neutra del pavimento 120x120 cm è una base perfetta alla quale abbinare sia toni delicati in formato 60x120 cm che grandi lastre colorate in formato 120x278 cm. Il formato 120x120 cm è disponibile nella doppia finitura Silk e Matt.

La modularité de la collection permet de combiner différentes tailles en fonction de la zone à revêtir. La teinte neutre du sol de 120x120 cm est une base parfaite pour assortir à la fois des tons délicats dans le format 60x120 cm et de grandes dalles colorées dans le format 120x278 cm. Le format 120x120 cm est disponible dans les doubles finitions Silk et Matt.

Die Modularität der Kollektion ermöglicht es, je nach dem zu verkleidenden Bereich verschiedene Formate zusammen zu stellen. Der neutrale Farbton der Bodenfliese 120x120 cm ist eine perfekte Basis, die sowohl zu zarten Farbtönen im Format 60x120 cm als auch zu großen farbigen Platten im Format 120x278 cm passt. Das Format 120x120 cm ist in der doppelten Oberflächenausführung Silk und Matt erhältlich.

La modularidad de la colección permite combinar diferentes tamaños según la zona a revestir. La tonalidad neutra del pavimento 120x120 cm es una base perfecta para combinar tanto tonos delicados en formato 60x120 cm como grandes losas de color en formato 120x278 cm. El formato 120x120 cm está disponible en doble acabado Silk y Matt.

Модульность коллекции позволяет сочетать различные форматы в зависимости от размеров оформляемого помещения. К нейтральному тону напольной плитки 120x120 см можно приставить как delicate оттенки формата 60x120 см, так и яркие цвета больших плит 120x278 см. Формат 120x120 см доступен в двух вариантах поверхности: Silk и Matt.

INDEX

OVERVIEW

SPACES

RANGE

TECH. SPECS



atlas concorde

LIVING COLORS

THE SILK FINISH IN THE 120x120 cm FORMAT COMBINES THE EFFECT OF TROWELED RESIN WITH THE ADVANTAGE OF HIGH RESISTANCE TO STAINS, BACTERIA, MOLDS, AND MOISTURE.

LA FINITURA SILK NEL FORMATO 120x120 cm CONIUGA L'EFFETTO DI UNA RESINA SPATOLATA AL VANTAGGIO DELL'ELEVATA RESISTENZA A MACCHIE, BATTERI, MUFFE E UMIDITÀ.

LA FINITION SILK EN 120x120 cm COMBINE L'EFFET D'UNE RÉSINE SPATULÉE AVEC L'AVANTAGE D'UNE GRANDE RÉSISTANCE AUX TACHES, AUX BACTÉRIES, À LA MOISSURE ET À L'HUMIDITÉ.

DIE OBERFLÄCHENAUSFÜHRUNG SILK IM FORMAT 120x120 cm VERBINDET DIE OPTIK EINES GESPACHELTEN HARZES MIT DEM VORTEIL EINER HOHEN BESTÄNDIGKEIT GEGEN FLECKEN, BAKTERIEN, SCHIMMEL UND FEUCHTIGKEIT.

EL ACABADO SILK EN FORMATO 120x120 cm COMBINA EL EFECTO DE UNA RESINA ESPATULADA CON LA VENTAJA DE UNA ALTA RESISTENCIA A LAS MANCHAS, LAS BACTERIAS, EL MOHO Y LA HUMEDAD.

ПОВЕРХНОСТЬ SILK В ФОРМАТЕ 120x120 CM СОЧЕТАЕТ ПРИЯТНЫЙ ЭФФЕКТ РАЗГЛАЖЕННОЙ ШПАТЕЛЕМ СМОЛЫ И ВЫСОКУЮ СТОЙКОСТЬ К ПЯТНАМ, БАКТЕРИЯМ, ПЛЕСЕНИ И ВЛАГЕ.



atlas concorde



DISPLAYED SURFACES

PORCELAIN TILES

Cord
Matte/Matt
120x278 cm | 47 1/4" x 109 1/2"

Cotton
Matte/Matt
120x278 cm | 47 1/4" x 109 1/2"

PORCELAIN TILES

Emerald
Matte/Matt
120x278 cm | 47 1/4" x 109 1/2"

Suede
Silk/Silk
120x120 cm | 47 1/4" x 47 1/4"

PORCELAIN TILE DECORS

Brush
120x278 cm | 47 1/4" x 109 1/2"

SOFT COMBINATIONS



atlas concorde

RESTAURANT

hen combined with cool colors, the neutral tones Fog and Cloud create a contemporary, exclusive environment. The Midnight and Dusk shades are made using a technique that gives surfaces a particular brilliance and intense depth of color.

Abbinati ai colori freddi, i toni neutri Fog e Cloud danno vita a un ambiente contemporaneo ed esclusivo. Le tonalità Midnight e Dusk sono realizzate con una tecnica che dona alle superfici una particolare brillantezza e un'intensa profondità cromatica.

Combinés à des couleurs froides, les tons neutres de Fog et Cloud créent un environnement contemporain et exclusif. Les nuances Midnight et Dusk sont réalisées avec une technique qui donne aux surfaces une brillance particulière et une profondeur chromatique intense.

Kombiniert mit den kalten Farben kreieren die neutralen Farbtöne Fog und Cloud eine zeitgenössische und exklusive Umgebung. Die Farbtöne Midnight und Dusk werden mit einer Technik hergestellt, die den Oberflächen einen besonderen Glanz und eine intensive Farbtiefe verleiht.

Combinados con colores fríos, los tonos neutros de Fog y Cloud crean un ambiente contemporáneo y exclusivo. Las tonalidades Midnight y Dusk están realizadas con una técnica que da un brillo particular a las superficies así como una intensa profundidad cromática.

Нейтральные цвета Fog и Cloud в сочетании с холодными создают эксклюзивную современную обстановку. Технология изготовления цветов Midnight и Dusk придает поверхностям необыкновенный блеск и глубину.

INDEX

OVERVIEW

SPACES

RANGE

TECH. SPECS



DISPLAYED SURFACES

PORCELAIN TILES

- | | |
|--|---|
| Graphite
Matte/Matt
120x278 cm 47 1/4" x 109 1/2" | Cloud
Matte/Matt
120x278 cm 47 1/4" x 109 1/2" |
| Dusk
Matte/Matt
120x278 cm 47 1/4" x 109 1/2" | Graphite
Matte/Matt
120x120 cm 47 1/4" x 47 1/4" |
| Midnight
Matte/Matt
120x278 cm 47 1/4" x 109 1/2" | Fog
Matte/Matt
120x120 cm 47 1/4" x 47 1/4" |

PORCELAIN TILE DECORS

- Gradient**
120x278 cm | 47 1/4" x 109 1/2"

PERFORMANCE AND BEAUTY

HOME SPA



atlas concorde

Porcelain wall tiles ensure maximum hygiene, are easy to clean, and prevent the proliferation of mold and bacteria.

Il rivestimento in gres porcellanato assicura la massima igiene, è semplice da pulire e impedisce la proliferazione di muffe e batteri.

Le revêtement en grès cérame assure une hygiène maximale, est facile à nettoyer et empêche la prolifération des moisissures et des bactéries.

Die Feinsteinzeugverkleidung gewährleistet maximale Hygiene, ist leicht zu reinigen und verhindert die Vermehrung von Schimmel und Bakterien.

El revestimiento de gres porcelánico asegura la máxima higiene, es fácil de limpiar y evita la proliferación de moho y bacterias.

Настенная облицовка из керамогранита гигиенична, проста в уходе, препятствует размножению плесени и бактерий.

INDEX

OVERVIEW

SPACES

RANGE

TECH. SPECS



**UNIQUE
AMBIANCE**





atlas concorde



atlas concorde

DISPLAYED SURFACES

PORCELAIN TILES

Cord
Matte/Matt
120x278 cm | 47 1/4" x 109 1/2"

Emerald
Matte/Matt
120x278 cm | 47 1/4" x 109 1/2"

Moss
Matte/Matt
120x278 cm | 47 1/4" x 109 1/2"

Suede
Matte/Matt
120x120 cm | 47 1/4" x 47 1/4"

PORCELAIN TILE DECORS

Suede
Mosaico Maze
31x35,7 cm - 12 1/4" x 14"

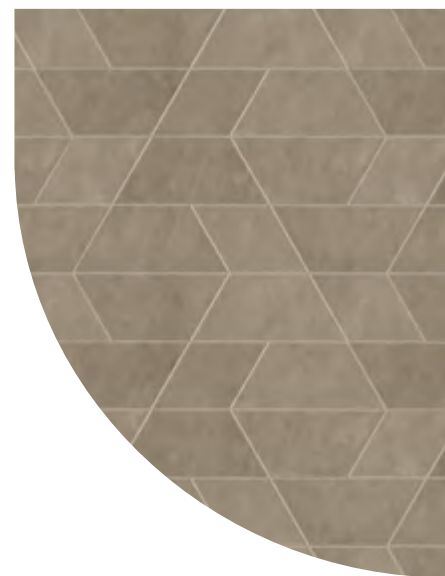

EXPAND YOUR LIMITS



The combination of the Midnight and Dusk colors of the 50x120 cm wall tiles adds depth to the bathroom with a continuous shading. The modularity of the floor and wall formats expands the design possibilities.

L'accostamento dei colori Midnight e Dusk del rivestimento nel formato 50x120 cm conferisce profondità al bagno con una sfumatura continua. La modularità dei formati a pavimento e a rivestimento amplia le possibilità progettuali.

La combinaison des couleurs Midnight et Dusk en 50x120 cm donne de la profondeur à la salle de bain avec une ombre continue. La modularité des carreaux et des dalles élargit les possibilités de conception.

Die Kombination der Farben Midnight und Dusk der Wandfliesen im Format 50x120 cm verleiht dem Badezimmer mittels einer durchgehenden Farbnuance Tiefe. Die Modularität der Boden- und Wandfliesen erweitert die Gestaltungsmöglichkeiten.

La combinación de colores Midnight e Dusk del revestimiento en formato 50x120 cm da profundidad al baño con un continuo matiz. La modularidad de los formatos a pavimento y revestimiento amplía las posibilidades de diseño.

Сочетание цветов Midnight и Dusk на настенном формате 50x120 см придает ванной комнате приятную глубину. Модульность напольных и настенных форматов значительно расширяет дизайнерский потенциал коллекции.



atlas concorde



atlas concorde

DEEP SURFACE



INDEX

OVERVIEW

SPACES

RANGE

TECH. SPECS



THE GRADIENT DECORATION REPRODUCES THE EFFECT OF DRY BRUSHING ENRICHED BY A CANVAS EFFECT AND THE OVERLAPPING OF A STRIPED TEXTURE. AVAILABLE IN BOTH 50x120 cm AND 120x278 cm PORCELAIN TILES.

IL DECORO GRADIENT RIPRODUCE L'EFFETTO DELLE LAVORAZIONI A PENNELLO ASCIUTTO, ARRICCHITE DALLA TRAMA TIPICA DELLA TELA E DALLA SOVRAPPOSIZIONE DI UNA TEXTURE RIGATA. DISPONIBILE SIA NEL FORMATO 50x120 cm CHE NEL FORMATO 120x278 cm IN GRES PORCELLANATO.

LA DÉCORATION GRADIENT REPRODUIT L'EFFET DES PROCESSUS AU PINCEAU SEC, ENRICHIS PAR LE TISSAGE TYPIQUE DE LA TOILE ET LE CHEVAUCHEMENT D'UNE TEXTURE RAYÉE. DISPONIBLE EN GRÈS CÉRAME DANS LE FORMAT 50x120 cm ET DANS LE FORMAT 120x278 cm.

DAS DEKOR GRADIENT REPRODUZIERT DIE WIRKUNG DER TROCKENPINSSELTECHNIK, DIE DURCH DIE TYPISCHE WEBART DER LEINWAND UND DIE ÜBERLAPPUNG EINER GERILLTEN STRUKTUR BEREICHERT WIRD. ERHÄLTICH IN FEINSTEINZEUG SOWOHL IM FORMAT 50x120 cm ALS AUCH IM FORMAT 120x278 cm.

LA DECORACIÓN GRADIENT REPRODUCE EL EFECTO DE LAS ELABORACIONES CON PINCEL SECO, ENRIQUECIDAS POR LA TRAMA TÍPICA DEL LIENZO Y LA SUPERPOSICIÓN DE UNA TEXTURA A RAYAS. DISPONIBLES TANTO EN EL FORMATO 50x120 cm COMO EN EL FORMATO 120x278 cm EN GRES PORCELÁNICO.

ДЕКОР GRADIENT ИМИТИРУЕТ ЭФФЕКТ ОБРАБОТКИ ХОЛСТА СУХОЙ КИСТЬЮ С НАЛОЖЕНИЕМ ПОЛОСАТОЙ ТЕКСТУРЫ. ДОСТУПЕН КАК В ФОРМАТЕ 50x120 см, ТАК И В ФОРМАТЕ 120x278 см ИЗ КЕРАМОГРАНИТА.



RESIN-EFFECT CERAMIC WALL TILES ALLOW CUSTOMIZING PALETTES WITH VIVID COLOR COMBINATIONS THAT GUARANTEE COLOR CONSISTENCY OVER TIME.

IL RIVESTIMENTO CERAMICO EFFETTO RESINA CONSENTE DI PERSONALIZZARE GLI ABBINAMENTI CON ACCOSTAMENTI CROMATICI VIVACI GARANTENDO COSTANZA DEL COLORE NEL TEMPO.

LE REVÊTEMENT CÉRAMIQUE À EFFET RÉSINE PERMET DE PERSONNALISER LES COMBINAISONS AVEC DES COMBINAISONS DE COULEURS VIVES, GARANTISSANT AINSI LA CONSTANCE DES COULEURS DANS LE TEMPS.

DIE KERAMIKVERKLEIDUNG MIT HARZOPTIK ERMÖGLICHT INDIVIDUELLE ZUSAMMENSTELLUNGEN MIT LEBHAFTEN FARBKOMBINATIONEN UND GARANTIERT DIE FARBBESTÄNDIGKEIT IM LAUFE DER ZEIT.

EL REVESTIMIENTO CERÁMICO EFECTO RESINA PERMITE PERSONALIZAR LAS COMBINACIONES CON COLORES VIVOS, GARANTIZANDO LA CONSISTENCIA DEL COLOR A LO LARGO DEL TIEMPO.

ПЛИТКА С ФАКТУРОЙ СМОЛЫ ПОЗВОЛЯЕТ ИНДИВИДУАЛИЗИРОВАТЬ ИНТЕРЬЕРЫ ЯРКИМИ ЦВЕТОВЫМИ СОЧЕТАНИЯМИ, ПРИ ЭТОМ ЦВЕТА СОХРАНЯЮТ СВОЙ ПЕРВОНАЧАЛЬНЫЙ ВИД ДАЖЕ ПОСЛЕ ДОЛГИХ ЛЕТ ЭКСПЛУАТАЦИИ.



atlas concorde



DISPLAYED SURFACES

WALL TILES

Dusk
Matte/Matt
50x120 cm | 19⁵/₈"x47¹/₄"

Midnight
Matte/Matt
50x120 cm | 19⁵/₈"x47¹/₄"

Cloud
Matte/Matt
50x120 cm | 19⁵/₈"x47¹/₄"

WALL TILE DECORS

Gradient
50x120 cm | 19⁵/₈"x47¹/₄"

WALL TRIM TILES

Dusk Corner
1,4x50 cm | 5⁵/₈"x19⁵/₈"

Cloud Corner
1,4x50 cm | 5⁵/₈"x19⁵/₈"

Midnight Corner
1,4x50 cm | 5⁵/₈"x19⁵/₈"

Cloud Corner A.E.
1,4x1,4 cm | 5⁵/₈"x5⁵/₈"

PORCELAIN TILES

Cloud
Matte/Matt
120x120 cm | 47¹/₄"x47¹/₄"



atlas concorde

THE ESSENCE OF PERSONALITY



PRIVATE BATHROOM

INDEX

OVERVIEW

SPACES

RANGE

TECH. SPECS

The Emerald and Moss colors allow for original tone-on-tone combinations to create a smooth, uniform environment that is slightly velvety to the touch.

Le varianti di colore Emerald e Moss permettono originali abbinamenti tono su tono per realizzare un ambiente morbido e uniforme, con un effetto leggermente vellutato al tatto.

Les variantes de couleurs Emerald et Moss permettent des combinaisons ton sur ton originales pour créer un environnement doux et uniforme avec un toucher légèrement velouté.

Die Farbvarianten Emerald und Moss ermöglichen originelle Ton-in-Ton-Kombinationen, um eine weiche und einheitliche Umgebung mit einem leicht samtigen Berührungsempfinden zu schaffen.

Las variantes de color Emerald y Moss permiten combinaciones originales tono sobre tono para crear un ambiente suave y uniforme con una sensación ligeramente aterciopelada.

Бархатистые на ощупь цвета Emerald и Moss позволяют создавать сочетания тон в тон, наполняющие интерьер спокойным уютом.

atlas concorde

ALL THE COLOR YOU SEE



THE 50x120 cm WHITE BODY WALL TILES ARE MODULAR WITH THE PORCELAIN FLOOR TILES, FOR RESIN-EFFECT SURFACES IN EVERY SPACE OF THE HOUSE.

IL FORMATO 50x120 cm A RIVESTIMENTO IN PASTA BIANCA È MODULARE CON I FORMATI A PAVIMENTO IN GRES PORCELLANATO, PER SUPERFICI EFFETTO RESINA IN OGNI SPAZIO DELLA CASA.

LE FORMAT 50x120 cm AVEC DES DALLES EN PÂTE BLANCHE EST MODULAIRE AVEC LES CARREAUX EN GRÈS CÉRAMÉ, POUR DES SURFACES À EFFET DE RÉSINE DANS TOUS LES ESPACES DE LA MAISON.

DAS FORMAT 50x120 cm DER WEISSSCHERBIGEN WANDFLIESEN WEIST FÜR OBERFLÄCHEN MIT HARZOPTIK IN JEDEM RAUM DER HAUSE EINE MODULARITÄT MIT DEN BODENFLIESEN AUS FEINSTEINZEUG AUF.

EL FORMATO 50x120 cm A REVESTIMIENTO EN PASTA BLANCA ES MODULAR CON LOS FORMATOS A PAVIMENTO DE GRES PORCELÁNICO, PARA SUPERFICIES EFECTO RESINA EN CADA ESPACIO DE LA CASA.

ФОРМАТ 50x120 см НАСТЕННОЙ ПЛИТКИ ИЗ БЕЛОЙ ГЛИНЫ СОЧЕТАЕТСЯ ПО РАЗМЕРУ С НАПОЛЬНЫМ КЕРАМОГРАНИТОМ, ДАВАЯ ВОЗМОЖНОСТЬ ЦЕЛЬНО УКРАШАТЬ ЛЮБОЕ ПОМЕЩЕНИЕ ДОМА.

INDEX

OVERVIEW

SPACES

RANGE

TECH. SPECS



DISPLAYED SURFACES

WALL TILES

Emerald
Matte/Matt
50x120 cm | 19⁵/₈"x47¹/₄"

Moss
Matte/Matt
50x120 cm | 19⁵/₈"x47¹/₄"

WALL TILE DECORS

Brush
50x120 cm | 19⁵/₈"x47¹/₄"

WALL TRIM TILES

Emerald Corner
1,4x50 cm | 5⁵/₈"x19⁵/₈"

Moss Corner
1,4x50 cm | 5⁵/₈"x19⁵/₈"

PORCELAIN TILES

Fog
Matte/Matt
120x278 cm | 47¹/₄"x109¹/₂"

Fog
Matte/Matt
120x120 cm | 47¹/₄"x47¹/₄"

COLOR DESIGN

WITH PRISM, EVERY ENVIRONMENT CONVEYS THE PERSONALITY OF THOSE WHO LIVE THERE. WHETHER TONE-ON-TONE OR CONTRASTING COMBINATIONS, THE WIDE RANGE OF COLORS ALLOWS FOR MAXIMUM CREATIVITY AND MAKES COLOR A PART OF LIFE.

CON PRISM OGNI AMBIENTE INTERPRETA AL MEGLIO LA PERSONALITÀ DI CHI LO VIVE. ABBINAMENTI TONO SU TONO O A CONTRASTO, L'AMPIA GAMMA CROMATICA NON PONE LIMITI ALLA PROGETTUALITÀ E IL COLORE DIVENTA PARTE DEL VIVERE.

AVEC PRISM, CHAQUE ENVIRONNEMENT INTERPRÈTE LA PERSONNALITÉ DE LA PERSONNE QUI LE VIT. QU'ELLE SOIT TON SUR TON OU CONTRASTÉE, LA LARGE GAMME DE COULEURS NE POSE AUCUNE LIMITE AU DESIGN ET LA COULEUR DEVIENT PARTIE INTÉGRANTE DE LA VIE.

MIT PRISM INTERPRETIERT JEDE UMGEBUNG AM BESTEN DIE PERSÖNLICHKEIT DER MENSCHEN, DER IN IHR LEBEN. OB KOMBINATIONEN TON-IN-TON ODER KONTRASTIEREND, DIE BREITE FARBPALLETTE SETZT DER PLANUNG KEINE GRENZEN UND DIE FARBE WIRD ZUM BESTANDTEIL DES LEBENS.

CON PRISM CADA AMBIENTE INTERPRETA LA PERSONALIDAD DE QUIEN LO VIVE. COMBINACIONES TONO SOBRE TONO O EN CONTRASTE, LA AMPLIA GAMA DE COLORES NO FIJA LÍMITES AL DISEÑO Y EL COLOR SE CONVIERTE EN PARTE DE LA VIDA.

ПЛИТКА PRISM ПОЗВОЛЯЕТ ПОДСТРАИВАТЬ ИНТЕРЬЕР ПОД ХАРАКТЕР ЕГО ХОЗЯЕВ. СОЧЕТАНИЯ ТОН В ТОН ИЛИ КОНТРАСТНЫЕ КОМБИНАЦИИ – ШИРОКАЯ ГАММА ЦВЕТОВ НЕ УСТАНАВЛИВАЕТ НИКАКИХ ГРАНИЦ ДЛЯ ДИЗАЙНА. И ЦВЕТ СТАНОВИТСЯ ЧАСТЬЮ ЖИЗНИ.



DISPLAYED SURFACES

1

WALL TILES

Caramel
Matte/Matt
50x120 cm | 19⁵/₈"x47¹/₄"

Cotton
Matte/Matt
50x120 cm | 19⁵/₈"x47¹/₄"

PORCELAIN TILES

Cord
Matte/Matt
60x120 cm | 23⁵/₈"x47¹/₄"

WALL TILE DECORS

Caramel Mosaico Bead
29,7x29,6 cm | 11⁵/₈"x11⁵/₈"

2

WALL TILES

Bloom
Matte/Matt
50x120 cm | 19⁵/₈"x47¹/₄"

Cloud
Matte/Matt
50x120 cm | 19⁵/₈"x47¹/₄"

PORCELAIN TILES

Graphite
Matte/Matt
60x120 cm | 23⁵/₈"x47¹/₄"

WALL TILE DECORS

Gold
Matte/Matt
50x120 cm | 19⁵/₈"x47¹/₄"

3

WALL TILE DECORS

Gold
Matte/Matt
50x120 cm | 19⁵/₈"x47¹/₄"

INDEX

OVERVIEW

SPACES

RANGE

TECH. SPECS

TOTAL RESIN LOOK



atlasconcorde

WELLNESS ROOM

With Prism, color becomes the linchpin of any interior design. The combination of warm tones is enhanced by the Grape accent, for environments with a strong personality.

Con Prism il colore diventa l'elemento cardine in ogni progetto di interni. L'abbinamento delle tonalità calde viene esaltato dall'accento di Grape, per ambienti dalla forte personalità.

Avec Prism, la couleur devient l'élément clé de tout projet de décoration d'intérieur. La combinaison de teintes chaudes est mise en valeur par l'accent de Grape, pour les environnements à forte personnalité.

Mit Prism wird die Farbe bei jedem Innenarchitekturprojekt zum Schlüsselement. Die Kombination warmer Farbtöne wird für äußerst charakteristische Umgebungen durch den Akzent von Grape verstärkt.

Con Prism el color se convierte en el elemento central de cada diseño interior. La combinación de tonalidades cálidas se realza con el acento de Grape creando ambientes con una fuerte personalidad.

Благодаря Prism цвет становится центральным элементом интерьерного дизайна. В теплые тона интерьера акцентно вкрапливается более холодный оттенок Grape, придающий обстановке яркую индивидуальность.

INDEX

OVERVIEW

SPACES

RANGE

TECH. SPECS

THE TOUCH OF COLOR



THE SURFACE GRAPHICS ARE PERFECTLY SUITED TO ANY SIZE. THE SUBTLE TROWEL LINES GUARANTEE A HARMONIOUS, ELEGANT EFFECT.

LA GRAFICA DELLA SUPERFICIE SI ADATTA PERFETTAMENTE A OGNI FORMATO. LE SPATOLATURE APPENA ACCENNATE GARANTISCONO UN EFFETTO ARMONICO ED ELEGANTE.

LES GRAPHISMES DE SURFACE S'ADAPTENT PARFAITEMENT À TOUS LES FORMATS. LES TRACES DE LA SPATULE, À PEINE ÉVOQUÉES, GARANTISSENT UN EFFET HARMONIEUX ET ÉLÉGANT.

DIE OBERFLÄCHENGRAFİK PASST SICH PERFEKT JEDEM FORMAT AN. DIE NUR ANGEDEUTETEN SPACHTELUNGEN GEWÄHRLEISTEN EINE HARMONISCHE UND ELEGANTE OPTIK.

LOS GRÁFICOS DE LA SUPERFICIE SE ADAPTAN PERFECTAMENTE A CUALQUIER FORMATO. EL ESPATULADO LIGERO GARANTIZA UN EFECTO HARMÓNICO Y ELEGANTE.

РИСУНОК СМОЛЫ ВЕЛИКОЛЕПНО СМОТРИТСЯ НА ЛЮБОМ ФОРМАТЕ. ЕДВА УЛОВИМЫЙ РЕЛЬЕФ ДАЕТ ОЩУЩЕНИЕ ГАРМОНИИ И ЭЛЕГАНТНОСТИ.



atlas concorde

DISPLAYED SURFACES

WALL TILES

Cord
Matte/Matt
50x120 cm | 19⁵/₈"x47¹/₄"

Bloom
Matte/Matt
50x120 cm | 19⁵/₈"x47¹/₄"

Grape
Matte/Matt
50x120 cm | 19⁵/₈"x47¹/₄"

WALL TILE DECORS

Bloom
Mosaico Wiggle
30,6x32,4 cm - 12"x12³/₄"

WALL TRIM TILES

Cord Corner
1,4x50 cm | 5⁵/₈"x19⁵/₈"

Bloom Corner
1,4x50 cm | 5⁵/₈"x19⁵/₈"

PORCELAIN TILES

Suede
Matte/Matt
120x120 cm | 47¹/₄"x47¹/₄"

WELLNESS ROOM

AN ELEGANT GEOMETRIC DECORATION AVAILABLE IN DIFFERENT COLOR COMBINATIONS, MOSAICO WIGGLE ALLOWS DECORATING THE WALLS WITH A THREE-DIMENSIONAL PATTERN.

ELEGANTE DECORO GEOMETRICO DISPONIBILE IN DIVERSI ABBINAMENTI CROMATICI, IL MOSAICO WIGGLE PERMETTE DI RIVESTIRE LE PARETI CON UN PATTERN TRIDIMENSIONALE.

ÉLÉGANTE DÉCORATION GÉOMÉTRIQUE DISPONIBLE DANS DIFFÉRENTES COMBINAISONS DE COULEURS, LE MOSAICO WIGGLE PERMET DE REVÊTIR LES MURS D'UN MOTIF TRIDIMENSIONNEL.

DAS MOSAICO WIGGLE IST EIN ELEGANTES GEOMETRISCHES DEKOR, DAS IN VERSCHIEDENEN FARBKOMBINATIONEN ERHÄLTICH IST UND DIE VERKLEIDUNG DER WÄNDE MIT EINEM DREIDIMENSIONALEN MUSTER ERMÖGLICHT.

ELEGANTE DECORACIÓN GEOMÉTRICA DISPONIBLE EN DIFERENTES COMBINACIONES DE COLORES, EL MOSAICO WIGGLE PERMITE REVESTIR LAS PAREDES CON UN PATRÓN TRIDIMENSIONAL.

ЭЛЕГАНТНАЯ ГЕОМЕТРИЧНАЯ МОЗАИКА WIGGLE ДОСТУПНА В РАЗНЫХ ЦВЕТОВЫХ СОЧЕТАНИЯХ И ПОЗВОЛЯЕТ УКРАСИТЬ СТЕНЫ ИЗЫСКАННЫМ ТРЕХМЕРНЫМ УЗОРОМ.



atlas concorde



atlas concorde

PRISM ENIGMA

THE ENIGMA DECORATION CREATES A GEOMETRIC PATTERN THAT MATCHES THE ENTIRE COLOR RANGE OF THE RESIN-EFFECT SURFACES OF THE PRISM COLLECTION.

IL DECORO ENIGMA CREA UN MOTIVO GEOMETRICO CHE SI ABBINA A TUTTA LA GAMMA CROMATICA DELLE SUPERFICI EFFETTO RESINA DELLA COLLEZIONE PRISM.

LA DÉCORATION ENIGMA CRÉE UN MOTIF GÉOMÉTRIQUE QUI CORRESPOND À TOUTE LA GAMME DES SURFACES À EFFET DE RÉSINE DE LA COLLECTION PRISM.

DAS DEKOR ENIGMA ERZEUGT EIN GEOMETRISCHES MUSTER, DAS ZUR GESAMTEN FARBPALETTE DER OBERFLÄCHEN MIT HARZOPTIK DER KOLLEKTION PRISM PASST.

LA DECORACIÓN ENIGMA CREA UN PATRÓN GEOMÉTRICO QUE SE COMBINA CON TODA LA GAMA DE COLORES DE LAS SUPERFICIES EFECTO RESINA DE LA COLECCIÓN PRISM.

ДЕКОР ENIGMA СОЗДАЕТ СТИЛЬНЫЙ ГЕОМЕТРИЧНЫЙ УЗОР, КОТОРЫЙ СОЧЕТАЕТСЯ СО ВСЕМИ ЦВЕТАМИ ПЛИТКИ ПОД СМОЛУ КОЛЛЕКЦИИ PRISM.



atlas concorde

WALL TILE DECORS

Enigma
50x120 cm - 19 7/8" x 47 1/4"

OPEN AIR SHADES

THE 120X120 CM SQUARE FORMAT, AVAILABLE IN 9 AND 20 MM THICKNESSES WITH A NON-SLIP GRIP FINISH, ALLOWS YOU TO DESIGN AN OUTDOOR SPACE IN TOTAL VISUAL CONTINUITY WITH INDOOR ENVIRONMENTS USING THE WARM SHADES OF CORD.

MIT DEM IN DEN STÄRKEN 20 MM BZW. 9 MM MIT RUTSCHFESTER OBERFLÄCHE GRIP ERHÄLTlichen, QUADRATISCHEN FORMAT 120X120 CM LASSEN SICH PERFEKT AUF DIE INNENRÄUME ABGESTIMMTE AUSSENBEREICHE IN DEN WARMEN NUANCEN VON CORD GESTALTEN.

IL FORMATO QUADRATO 120X120 CM, DISPONIBILE IN 20 MM DI SPESSORE O IN 9 MM CON LA FINITURA ANTISCIVOLO GRIP, PERMETTE DI PROGETTARE CON LE CALDE SFUMATURE DEL CORD UNO SPAZIO ESTERNO IN TOTALE CONTINUITÀ VISIVA CON GLI AMBIENTI INTERNI.

EL FORMATO CUADRADO DE 120X120 CM, DISPONIBLE EN 20 MM DE ESPESOS O EN 9 MM CON ACABADO ANTIDESLIZANTE GRIP, PERMITE DISEÑAR CON LOS TONOS CÁLIDOS DEL CORD UN ESPACIO EXTERIOR EN TOTAL CONTINUIDAD VISUAL CON LOS AMBIENTES INTERIORES.

LE FORMAT CARRÉ 120X120 CM, DISPONIBLE EN ÉPAISSEUR 20 MM OU EN 9 MM AVEC, EN OPTION, LA FINITION ANTIDÉRAPANTE GRIP, VOUS PERMET D'AMÉNAGER UN ESPACE EXTÉRIEUR AVEC LES NUANCES CHAUDES DE CORD EN CONTINUITÉ VISUELLE TOTALE AVEC L'INTÉRIEUR.

КВАДРАТНЫЙ ФОРМАТ 120X120 CM В ВАРИАНТЕ ТОЛЩИНЫ 20 MM ИЛИ 9 MM С ПРОТИВОСКОЛЬЗЯЩЕЙ ПОВЕРХНОСТЬЮ GRIP ПОЗВОЛЯЕТ ОФОРМЛЯТЬ ТЕПлыми ОТТЕНКАМИ CORD НАРУЖНЫЕ ПРОСТРАНСТВА СОЗВУЧНО ИНТЕРЬЕРАМ.



atlas concorde

DISPLAYED SURFACES

PORCELAIN TILES

Outdoor

Cord
Textured ✦ 20 mm
120x120 cm | 47 1/4" x 47 1/4"

Indoor

Cord
Matte/Matt
120x120 cm | 47 1/4" x 47 1/4"



atlas concorde

RANGE RECAP

A COLOR CONCEPT
BY PIERO LISSONI

PORCELAIN TILES

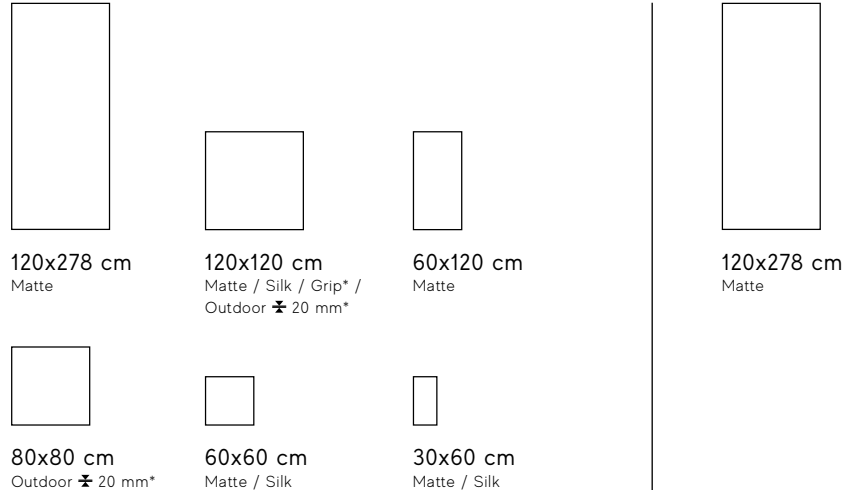

* Available in / Disponibile in:
Suede, Cord, Cloud, Fog

WALL TILES

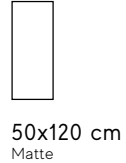

INDEX

OVERVIEW

SPACES

RANGE

TECH. SPECS

SUGGESTED COMBINATIONS

TONE ON TONE MATCHES

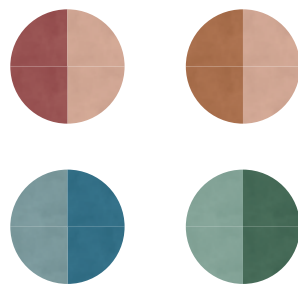

ACCENT MATCHES

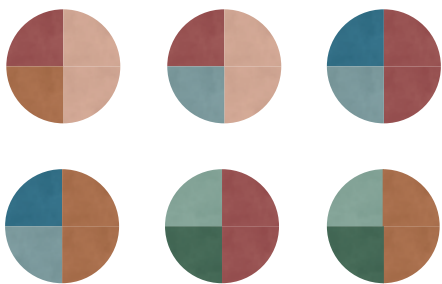

COLD MATCHES



WARM MATCHES



Porcelain tiles

COLOURED BODY PORCELAIN TILES - RECTIFIED MONOCALIBER

GRES PORCELLANATO COLORATO IN MASSA - RETTIFICATO MONOCALIBRO

Grès cérame coloré dans la masse - Rectifié mono-calibre / Durchgefärbtes Feinsteinzeug - Geschliffen einkalibrig / Gres porcelánico coloreado en masa - Rectificado monocalibre / Керамический гранит окрашенный в массе - Ретифицированный в одном калибре



GLAZED PORCELAIN TILES

GRES PORCELLANATO SMALTATO

Grès cérame émaillé / Glasiertes Feinsteinzeug / Gres porcelánico esmaltado / Глазурованный керамический гранит

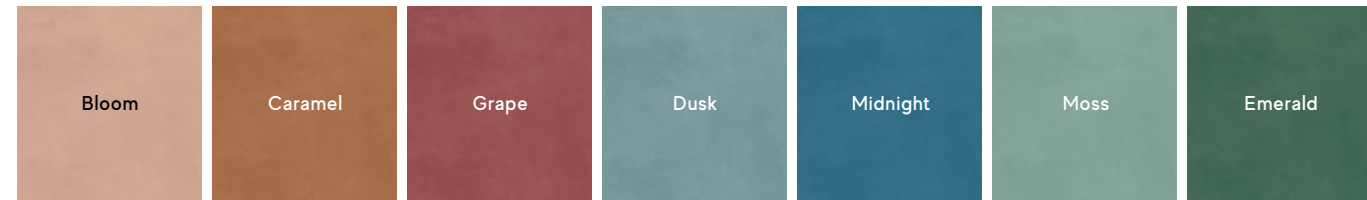

120x278 cm - 47 ¹ / ₄ "x109 ¹ / ₂ "	± 6 mm	Matte	Matte	Matte	Matte	Matte	Matte
120x120 cm - 47 ¹ / ₄ "x47 ¹ / ₄ "	± 9 mm	Silk Matte	Silk Matte	Silk Matte	Silk Matte	Silk Matte	Silk Matte
60x120 cm - 23 ⁵ / ₈ "x47 ¹ / ₄ "	± 9 mm	Matte	Matte	Matte	Matte	Matte	Matte
60x60 cm - 23 ⁵ / ₈ "x23 ⁵ / ₈ "	± 9 mm	Silk Matte	Silk Matte	Silk Matte	Silk Matte	Silk Matte	Silk Matte
30x60 cm - 11 ³ / ₄ "x23 ⁵ / ₈ "	± 9 mm	Silk Matte	Silk Matte	Silk Matte	Silk Matte	Silk Matte	Silk Matte



Matte	Matte	Matte	Matte	Matte	Matte	Matte

Outdoor and Wet Areas

120x120 cm - 47 ¹ / ₄ "x47 ¹ / ₄ "	± 9 mm	Grip	Grip		Grip	Grip	
	± 20 mm	Textured	Textured		Textured	Textured	
80x80 cm - 31 ¹ / ₂ "x31 ¹ / ₂ "	± 20 mm	Textured	Textured		Textured	Textured	

Wall tiles

WHITE-BODY WALL TILES - RECTIFIED MONOCALIBER

RIVESTIMENTI IN PASTA BIANCA - RETTIFICATO MONOCALIBRO

Revêtements en pâte blanche - Rectifié mono-calibre / Weißscherbige Wandfliesen - Geschliffen einkalibrig / Revestimientos en pasta blanca - Rectificado monocalibre / Настенная плитка из белой глины - Ретифицированный в одном калибре



50x120 cm - 19 ⁵ / ₈ "x47 ¹ / ₄ "	± 8,5 mm	Matte	Matte	Matte	Matte	Matte
---	----------	-------	-------	-------	-------	-------

Matte	Matte	Matte	Matte	Matte	Matte	Matte
-------	-------	-------	-------	-------	-------	-------

Porcelain tiles: note on silk finish / Gres porcellanato: nota sulla finitura silk

The silk finish is suitable for residential or low-traffic commercial floors, where no anti-slip performance is required. The surface's shine and great ease of cleaning are the result of in-depth studies and technical research aimed at ensuring its durability over time. If the product is in direct contact with the outdoors, moisture and dirt absorption devices must be used to prevent scratching. / La finitura silk è indicata per pavimenti residenziali o commerciali poco sollecitati, laddove non siano richieste prestazioni antiscivolo. La lucentezza e l'elevata facilità di pulizia della superficie sono frutto di studi approfonditi e accurate ricerche tecniche volte a garantirne la persistenza nel tempo. Se il prodotto è a diretto contatto con l'esterno, prevedere dei dispositivi di assorbimento dell'umidità e dello sporco per prevenire la formazione di graffi. / La finition soyeuse convient aux sols résidentiels ou commerciaux peu sollicités, où la performance antidérapante n'est pas requise. La brillance et la grande facilité de nettoyage de la surface sont le résultat d'études approfondies et de recherches techniques précises visant à garantir sa persistance dans le temps. Si le produit est en contact direct avec l'extérieur, prévoyez des dispositifs d'absorption de l'humidité et de la saleté pour éviter la formation de rayures. / Die Oberfläche Silk eignet sich für Bodenbeläge in Wohnbereichen bzw. in gering beanspruchten Gewerberäumen, wenn keine Rutschfestigkeit erforderlich ist. Der Glanz und die einfache Reinigung der Oberfläche sind das Resultat eingehender technischer Studien, mit denen die langfristige Beständigkeit sichergestellt wurde. Kommt das Produkt direkt mit der externen Umgebung in Kontakt, so sind Feuchtigkeit und Schmutz mit geeigneten Mitteln aufzunehmen, um Kratzer zu vermeiden. / El acabado Silk es adecuado para pavimentos residenciales o comerciales con poco tráfico, donde no se requiere un efecto antideslizante. El brillo y la gran facilidad de limpieza de la superficie son el resultado de profundos estudios e investigaciones técnicas precisas para asegurar su persistencia en el tiempo. Si el producto está en contacto directo con el exterior, proporcionar dispositivos de absorción de la humedad y suciedad para evitar los arañazos. / Поверхность Silk рекомендована для полов жилых и коммерческих помещений с невысокой интенсивностью эксплуатации, в которых от покрытий не требуется характеристик сопротивления скольжению. Блеск и легкая очищаемость являются результатом глубоких исследований, направленных на создание долговечного материала. Если плитка находится в непосредственном контакте с наружной средой, необходимо предусмотреть устройства поглощения влаги и грязи во избежание образования царапин.

Porcelain tiles Destination of use

M Matte ± 6 mm Silk ± 9 mm	H Matte ± 9 mm Grip ± 9 mm Textured ± 20 mm
--------------------------------------	--

Porcelain tiles Anti-slip

R9 A Matte ± 6 mm * R10 A+B Matte ± 9 mm R11 A+B+C Grip ± 9 mm Textured ± 20 mm
--

* Applies to / Valido per: Suede, Cord, Cotton, Cloud, Fog, Graphite

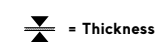

Color-shading

V2 Slight Variation

PRISM

Glazed porcelain tiles

Prism Bloom ± 6 mm ● ✎
120x278 cm - 47 1/4"x109 1/2"



Prism Caramel ± 6 mm ● ✎
120x278 cm - 47 1/4"x109 1/2"



Prism Grape ± 6 mm ● ✎
120x278 cm - 47 1/4"x109 1/2"



Prism Dusk ± 6 mm ● ✎
120x278 cm - 47 1/4"x109 1/2"



Prism Midnight ± 6 mm ● ✎
120x278 cm - 47 1/4"x109 1/2"



Prism Moss ± 6 mm ● ✎
120x278 cm - 47 1/4"x109 1/2"



Prism Emerald ± 6 mm ● ✎
120x278 cm - 47 1/4"x109 1/2"



✎ The decoration can only be laid on the wall. / Il decoro si può posare solo a rivestimento. / Décor uniquement mural. / Das Dekor kann nur an der Wand verlegt werden. / La decoración se puede colocar únicamente en paredes. / Декор может быть уложен только на стену.

● The use of a common mild detergent is recommended. Avoid using acidic or alkaline products, waxes, steel wool, or abrasives. / Si consiglia l'utilizzo di un comune detergente neutro. Evitare l'utilizzo di prodotti acidi o alcalini, ceranti, pagliette di metallo o abrasive. / Nous vous conseillons d'utiliser des détergents neutres courants. Éviter l'utilisation de cires et de produits acides ou alcalins, ainsi que les pailles métalliques ou abrasives. / Es empfiehlt sich, ein haushaltsübliches, neutrales Reinigungsmittel zu verwenden. Saure oder alkalische Produkte, Wachs sowie Metallwolle- bzw. Scheuerschwämme sind zu vermeiden. / Recomendamos utilizar un detergente neutro común. Hay que evitar el uso de productos ácidos o alcalinos, ceras y estropajos de metal o abrasivos. / Рекомендуется чистить обычным нейтральным моющим средством. Не рекомендуется использовать кислотные, щелочные, восковые средства, а также металлические мочалки.

INDEX

OVERVIEW

SPACES

RANGE

TECH. SPECS

PRISM

Porcelain tile decors

Prism Gradient ± 6 mm ●
120x278 cm - 47 $\frac{1}{4}$ "x109 $\frac{1}{2}$ "



Prism Brush ± 6 mm ●
120x278 cm - 47 $\frac{1}{4}$ "x109 $\frac{1}{2}$ "



- The use of a common mild detergent is recommended. Avoid using acidic or alkaline products, waxes, steel wool, or abrasives. / Si consiglia l'utilizzo di un comune detergente neutro. Evitare l'utilizzo di prodotti acidi o alcalini, ceranti, pagliette di metallo o abrasive. / Nous vous conseillons d'utiliser des détergents neutres courants. Éviter l'utilisation de cires et de produits acides ou alcalins, ainsi que les pailles métalliques ou abrasives. / Es empfiehlt sich, ein haushaltsübliches, neutrales Reinigungsmittel zu verwenden. Saure oder alkalische Produkte, Wachs sowie Metallwolle- bzw. Scheuerschwämme sind zu vermeiden. / Recomendamos utilizar un detergente neutro común. Hay que evitar el uso de productos ácidos o alcalinos, ceras y estropajos de metal o abrasivos. / Рекомендуется чистить обычным нейтральным моющим средством. Не рекомендуется использовать кислотные, щелочные, восковые средства, а также металлические мочалки.

- The decoration can only be laid on the wall. / Il decoro si può posare solo a rivestimento. / Décor uniquement mural. / Das Dekor kann nur an der Wand verlegt werden. / La decoración se puede colocar únicamente en paredes. / Декор может быть уложен только на стену.



Porcelain tile decors

Prism Cotton
Mosaico Maze
31x35,7 cm - 12¹/₄"x14"



Prism Cord
Mosaico Maze
31x35,7 cm - 12¹/₄"x14"



Prism Suede
Mosaico Maze
31x35,7 cm - 12¹/₄"x14"



Prism Cloud
Mosaico Maze
31x35,7 cm - 12¹/₄"x14"



Prism Fog
Mosaico Maze
31x35,7 cm - 12¹/₄"x14"



Prism Graphite
Mosaico Maze
31x35,7 cm - 12¹/₄"x14"



Prism Cotton
Mosaico Maze Silk
31x35,7 cm - 12¹/₄"x14"



Prism Cord
Mosaico Maze Silk
31x35,7 cm - 12¹/₄"x14"



Prism Suede
Mosaico Maze Silk
31x35,7 cm - 12¹/₄"x14"



Prism Cloud
Mosaico Maze Silk
31x35,7 cm - 12¹/₄"x14"



Prism Fog
Mosaico Maze Silk
31x35,7 cm - 12¹/₄"x14"



Prism Graphite
Mosaico Maze Silk
31x35,7 cm - 12¹/₄"x14"

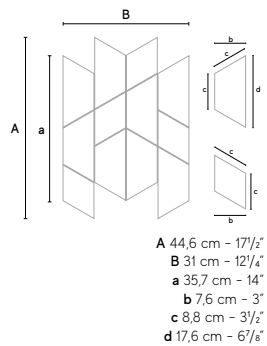

Prism Cotton
Mosaico Matt
30x30 cm - 11³/₄"x11³/₄"



Prism Cord
Mosaico Matt
30x30 cm - 11³/₄"x11³/₄"



Prism Suede
Mosaico Matt
30x30 cm - 11³/₄"x11³/₄"



Prism Cloud
Mosaico Matt
30x30 cm - 11³/₄"x11³/₄"



Prism Fog
Mosaico Matt
30x30 cm - 11³/₄"x11³/₄"

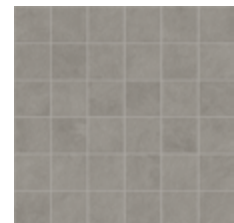

Prism Graphite
Mosaico Matt
30x30 cm - 11³/₄"x11³/₄"

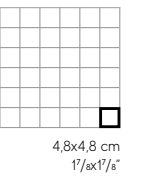

PRISM

Wall tile decors

Prism Brush ●

50x120 cm - 19⁵/₈"x47¹/₄"



8 patterns / 8 patterns

Prism Gradient ●

50x120 cm - 19⁵/₈"x47¹/₄"



12 patterns / 12 patterns



Prism Enigma

50x120 cm - 19⁵/₈"x47¹/₄"



This item matches with the following colors / Questo articolo si abbina ai colori seguenti:
Cloud 50x120, Graphite 50x120, Cotton 50x120

Prism Gold *

50x120 cm - 19⁵/₈"x47¹/₄"



This item matches with the following colors / Questo articolo si abbina ai colori seguenti:
Bloom 50x120, Caramel 50x120, Grape 50x120, Cord 50x120, Cloud 50x120, Suede 50x120, Cotton 50x120

● Item sold by square meter. / Articolo venduto al mq. / Article vendu au mètre carré. / Artikel pro m verkauft. / Artículo vendido por m. / Артикул продается квадратными метрами.

* For gold pieces, use an ordinary neutral cleaner. Avoid using acid or alkaline products, waxes and scour pads. / Parti in oro. Si consiglia l'utilizzo di un comune detergente neutro. Evitare l'utilizzo di prodotti acidi o alcalini, ceranti e pagliette di metallo. / Détails en or. Nous vous conseillons d'utiliser un détergent commun neutre. Evitez d'utiliser tout produit acide ou alcalin, cirants et grattoirs. / Vergoldete Teile. Verwenden Sie ein normales, neutrales Reinigungsmittel. Saure oder alkalische Produkte, Wachse und Metallschwämme sind zu vermeiden. / Partes de oro. Se aconseja utilizar un detergente neutro habitual. Hay que evitar el empleo de productos ácidos o alcalinos, ceras y estropajos de metal. / Золотые детали. Рекомендуется чистить обычным нейтральным моющим средством. Не рекомендуется использовать кислотные, щелочные, восковые средства, а также металлические мочалки.

INDEX

OVERVIEW

SPACES

RANGE

TECH. SPECS

Wall tile decors

Prism Cotton Mosaico Bead
29,7x29,6 cm - 11⁵/₈"x11⁵/₈"



Prism Cord Mosaico Bead
29,7x29,6 cm - 11⁵/₈"x11⁵/₈"



Prism Suede Mosaico Bead
29,7x29,6 cm - 11⁵/₈"x11⁵/₈"



Prism Cloud Mosaico Bead
29,7x29,6 cm - 11⁵/₈"x11⁵/₈"

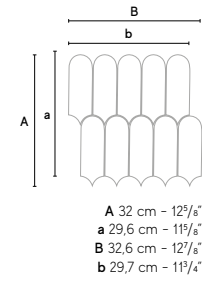

Prism Graphite Mosaico Bead
29,7x29,6 cm - 11⁵/₈"x11⁵/₈"



Prism Bloom Mosaico Bead
29,7x29,6 cm - 11⁵/₈"x11⁵/₈"



Prism Caramel Mosaico Bead
29,7x29,6 cm - 11⁵/₈"x11⁵/₈"



Prism Grape Mosaico Bead
29,7x29,6 cm - 11⁵/₈"x11⁵/₈"



Prism Dusk Mosaico Bead
29,7x29,6 cm - 11⁵/₈"x11⁵/₈"



Prism Midnight Mosaico Bead
29,7x29,6 cm - 11⁵/₈"x11⁵/₈"



Prism Moss Mosaico Bead
29,7x29,6 cm - 11⁵/₈"x11⁵/₈"



Prism Emerald Mosaico Bead
29,7x29,6 cm - 11⁵/₈"x11⁵/₈"



Prism Cotton Wiggle
30,6x32,4 cm - 12"x12³/₄"



Prism Bloom Wiggle
30,6x32,4 cm - 12"x12³/₄"



Prism Dusk Wiggle
30,6x32,4 cm - 12"x12³/₄"



Prism Moss Wiggle
30,6x32,4 cm - 12"x12³/₄"

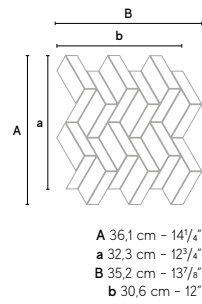

Prism Cotton Mosaic Q
30,5x30,5 cm - 12"x12"

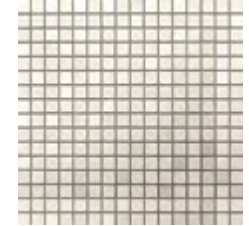

Prism Cord Mosaic Q
30,5x30,5 cm - 12"x12"

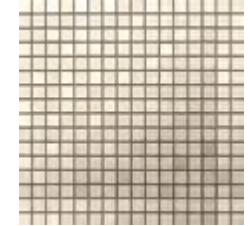

Prism Suede Mosaic Q
30,5x30,5 cm - 12"x12"

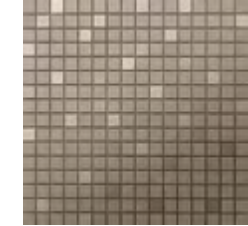

Prism Cloud Mosaic Q
30,5x30,5 cm - 12"x12"

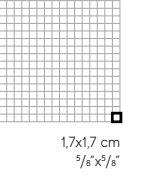
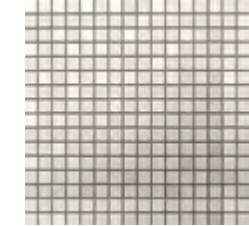

Prism Graphite Mosaic Q
30,5x30,5 cm - 12"x12"

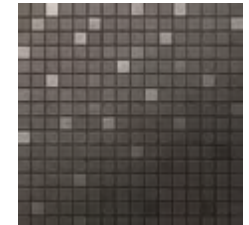

Prism Bloom Mosaic Q
30,5x30,5 cm - 12"x12"

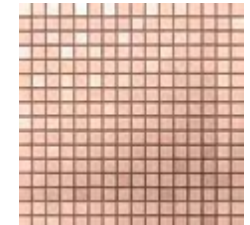

Prism Caramel Mosaic Q
30,5x30,5 cm - 12"x12"

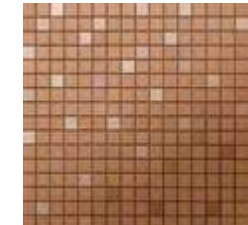

Prism Grape Mosaic Q
30,5x30,5 cm - 12"x12"

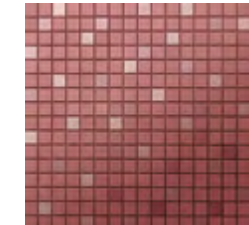

Prism Dusk Mosaic Q
30,5x30,5 cm - 12"x12"

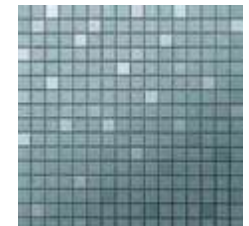

Prism Midnight Mosaic Q
30,5x30,5 cm - 12"x12"

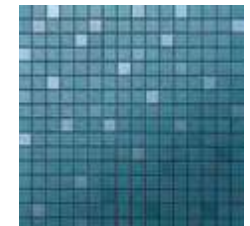

Prism Moss Mosaic Q
30,5x30,5 cm - 12"x12"

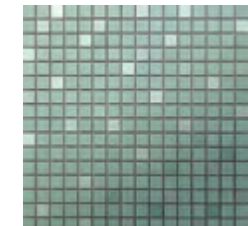

Prism Emerald Mosaic Q
30,5x30,5 cm - 12"x12"

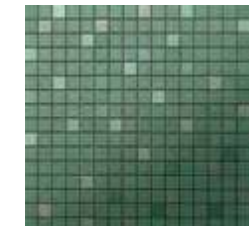

PRISM

Trim tiles

INDOOR TRIM TILES

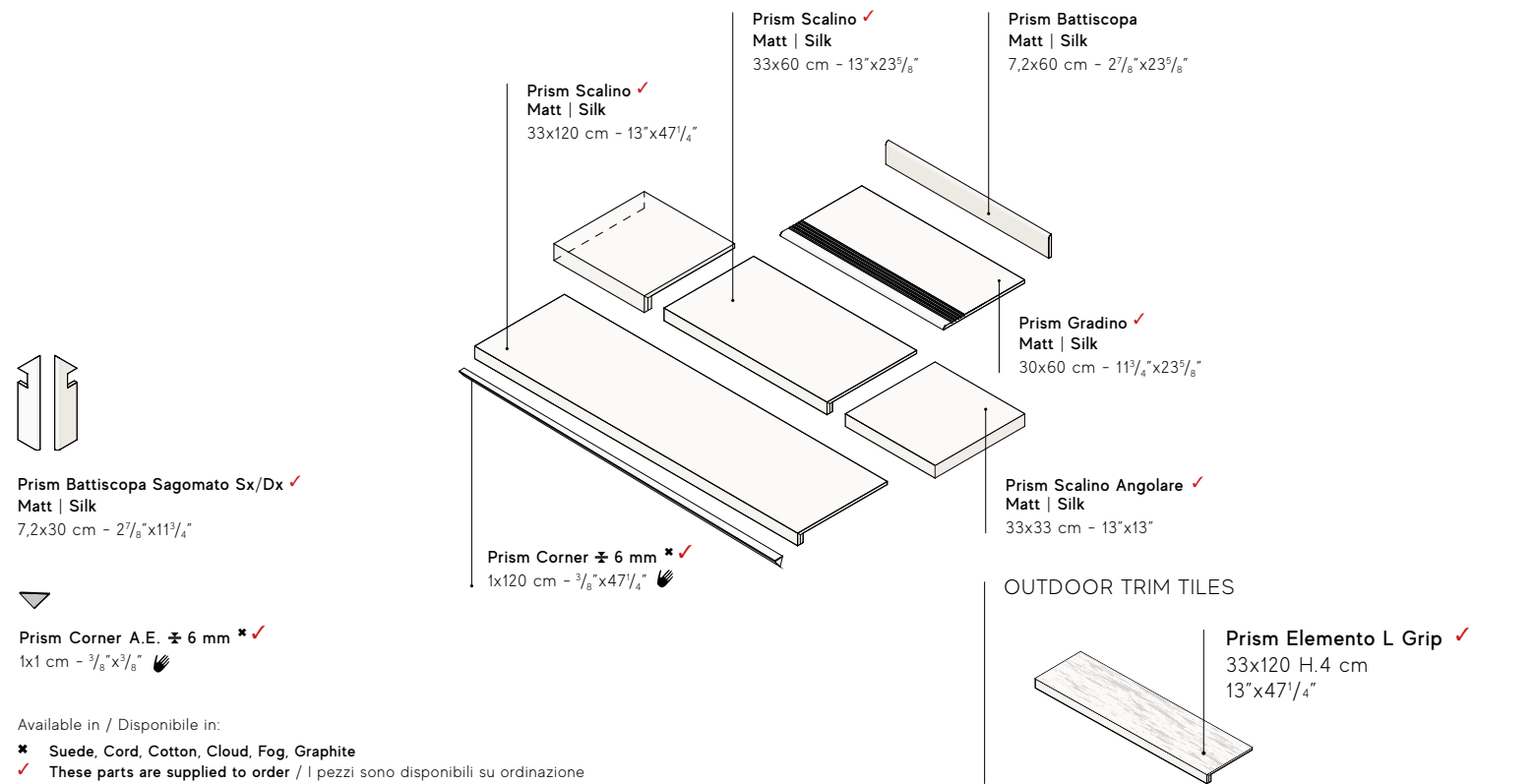

OUTDOOR TRIM TILES

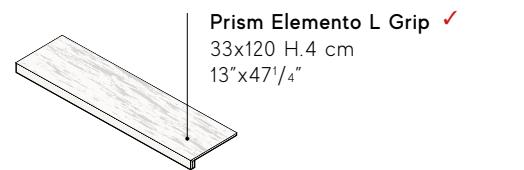

Outdoor trim tiles ± 20 mm

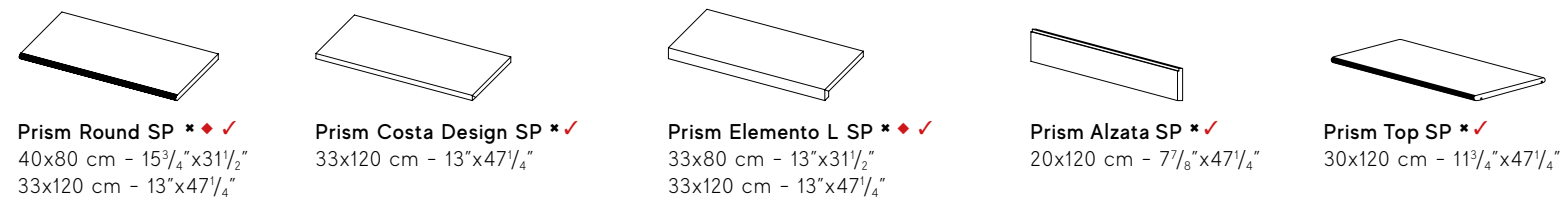

Available in / Disponibile in:
* Suede, Cord, Fog, Cloud
✓ These parts are supplied to order / I pezzi sono disponibili su ordinazione
♦ Right-left angular elements are available / Sono disponibili gli elementi angolari dx/sx

Wall trim tiles

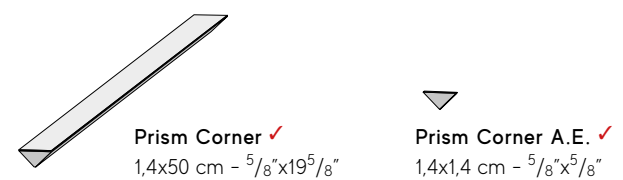

✓ These parts are supplied to order
I pezzi sono disponibili su ordinazione

Porcelain tiles ± 20 mm

For further details on the 20mm thick products, related trim pieces and installation systems - in particular for recommendations and precautions during installation- please refer to the Outdoor Design section on the website or to the Outdoor Design catalogue. Per dettagli sul prodotto e sui relativi pezzi speciali in 20mm di spessore, per i sistemi di posa e, in particolare, per raccomandazioni, accorgimenti e precauzioni in fase di posa e progettazione, si raccomanda di prendere visione del catalogo Outdoor Design e della sezione Outdoor Design del sito. / Pour plus de renseignements sur le produit, les pièces spéciales de 20mm d'épaisseur et sur les systèmes de pose, ainsi que pour tous conseils et recommandations et précautions d'emploi pendant la pose ou en phase de conception, nous vous recommandons de lire le catalogue Outdoor Design et de consulter la section Outdoor Design sur le site d'. / Bitte beachten Sie die detaillierten Informationen zum Produkt und zu den zugehörigen Formteilen in 20mm Stärke, zu den Verlegesystemen sowie vor allem die Empfehlungen, Tipps und bei der Planung und Verlegung zu beachtenden Vorsichtsmaßnahmen, die im Katalog Outdoor Design sowie im Bereich Outdoor Design der Website aufgeführt sind. / Para mayor información sobre el producto y sus relativas piezas especiales de 20mm de grosor, para los sistemas de colocación, y en particular, para las recomendaciones, precauciones y precauciones en la fase de colocación y diseño, se recomienda consultar el catálogo Outdoor Design y la sección Outdoor Design del sitio. / Подробнее о плитках и о специальных элементах толщиной 20мм, о системах монтажа, о мерах предосторожности при проектировании и укладке можно узнать в каталоге Outdoor Design и в разделе Outdoor Design на сайте.



THANKS TO

 www.fantini.it	 www.formaecollection.com
 www.zilioaldo.it	 www.ceramicacielo.it
 www.prandina.it	 www.bosatrade.com
 www.axolight.it	 www.bertocci.it
 www.bontempi.it	 www.miniforms.com
 www.belfortefragranze.com	 www.napatelier.com

Note

For information and details relating to codes, packaging and weight it is recommended to refer to the latest pricelist. / Per le informazioni e i dati relativi a codici, imballaggi e pesi occorre sempre consultare l'ultimo listino aggiornato e in vigore. / Pour toutes informations et renseignements concernant les codes, les emballages et les poids, il y a toujours lieu de consulter le dernier tarif en vigueur et mis à jour. / Für Informationen und Daten die den Code, die Verpackung und das Gewicht betreffen bitte die aktuellste Preisliste zugrunde legen. / Para acceder a la información y a los datos relativos a códigos, embalajes y pesos hay que consultar siempre la última lista de precios actualizada y vigente. / Для информации о кодах, упаковках и весе обращайтесь к последнему действующему прайс-листу.

Colors and optical features of the materials illustrated in this catalogue are to be regarded as mere indications. / I colori e le caratteristiche estetiche dei materiali illustrati nel presente catalogo sono da ritenersi puramente indicativi. / Les coloris et les caractéristiques esthétiques des références illustrées dans le catalogue sont donnés à titre purement indicatif. / Die Farben und die ästhetischen Eigenschaften der in diesem Katalog abgebildeten Produkte sind als reine Richtwerte zu betrachten. / Los colores y las características estéticas de los materiales ilustrados en el presente catálogo deben ser considerados como puramente indicativos. / Цвета и эстетические характеристики описанных в настоящем каталоге материалов являются только ориентировочными.

reserves the right to modify any product without notice and will not be liable for any direct or indirect damage resulting from such modifications. / si riserva di modificare i prodotti senza preavviso, declinando ogni responsabilità su eventuali danni diretti o indiretti derivanti da eventuali modifiche. / se réserve le droit de modifier ses produits sans préavis et décline toute responsabilité concernant les éventuels dommages directs ou indirects qui pourraient dériver de ces modifications. / behält sich das Recht vor jederzeit und ohne vorherige Ankündigung, die Produkte zu verändern, und lehnt jede Haftung bei direkten oder indirekten Schäden ab, die von diesen Veränderungen herrühren. / se reserva el derecho de modificar los productos sin previo aviso, rechaza cualquier responsabilidad sobre eventuales daños directos o indirectos derivados de eventuales modificaciones. / оставляет за собой право изменять характеристики изделий без предварительного уведомления, отклоняя при этом любую ответственность за прямые или косвенные убытки, возникшие в результате изменений.

PORCELAIN AND WALL TILES: A SAFE CHOICE

Resistance and duration

RESISTENZA E DURATA

Easy to maintain

Facile da mantenere



Porcelain tiles do not require any special maintenance.

Il gres porcellanato non richiede manutenzioni particolari.

UV Resistant

Resistente ai raggi UV



Porcelain tiles maintain their colors even when exposed to continuous, direct sunlight or in contact with atmospheric agents or smog.

Il gres porcellanato rimane inalterato nei suoi colori anche se esposto alla luce diretta e continua del sole o a contatto con agenti atmosferici o smog.

Scratch resistant

Resistente al graffio

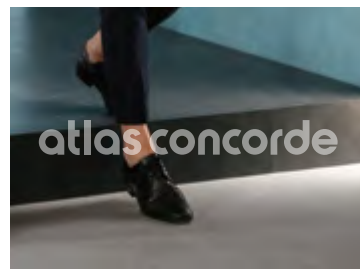

Porcelain tiles do not splinter, break or get damaged.

Il gres porcellanato non si scheggia, non si rompe e non si danneggia.

Easy to clean

Facile da pulire



Porcelain tiles are easy to clean.

Il gres porcellanato si pulisce facilmente.

Waterproof

Resistente all'acqua



Porcelain tiles are completely non-porous and therefore are not damaged by water or humidity.

Il gres porcellanato è completamente non poroso e non teme l'acqua e l'umidità.

Stain resistant

Resistente alle macchie



Porcelain tiles are waterproof, no liquid can damage the surface.

Il gres porcellanato è impermeabile e nessun tipo di liquido può danneggiare la superficie.

Resistant to chemicals

Resistente agli agenti chimici



Porcelain tiles do not stain and resist the most aggressive chemical agents.

Il gres porcellanato non si macchia e resiste agli agenti chimici più aggressivi.

Resistant to acids

Resistente agli acidi



Porcelain tiles are resistant to acids found in food and cleaning products.

Il gres porcellanato resiste agli acidi di uso alimentare e domestico.

Resistant to thermal shock

Resistente agli shock termici



A porcelain tile floor will not change as a result of sharp temperature fluctuations.

Un pavimento in gres porcellanato non si altera a causa di sbalzi termici.

Frost resistant

Resistente al ghiaccio



Porcelain tiles are frost resistant and therefore are not damaged by low temperatures.

Il gres porcellanato è ingelivo e resiste alle temperature più basse.

Health

SALUTE

Zero VOCS

Zero VOC



Porcelain tiles are intrinsically inorganic and do not emit volatile organic compounds (VOC).

Le piastrelle in gres porcellanato sono intrinsecamente inorganiche e non emettono composti organici volatili.

Zero PVC

Zero PVC



Porcelain tiles contain no PVC, plastics or petroleum derivatives.

Il gres porcellanato è privo di PVC, plastiche o derivati del petrolio.

Zero formaldehyde

Zero formaldeide



Porcelain tiles do not contain formaldehyde.

Il gres porcellanato non contiene formaldeide.

Zero allergens

Zero allergeni



Porcelain tiles are inhospitable for mites, bacteria, fungi, molds, and other irritants.

Il gres porcellanato è inospitale per acari, batteri, funghi, muffe e altre sostanze irritanti.

Prevent bacterial growth

Previene la crescita batterica



Porcelain tiles are completely hygienic and inhospitable for bacteria, mites, molds, and fungi.

Il gres porcellanato è assolutamente igienico e inospitale per i batteri, acari, muffe e funghi.

Safety

SICUREZZA

Non-slip

Antiscivolo



Porcelain tile surfaces can be made with an abrasive surface grit that can increase traction and reduce the risk of slipping.

Le superfici in gres porcellanato possono essere realizzate con una graniglia abrasiva superficiale in grado di aumentare la trazione e ridurre i rischi di scivolamento.

Fire resistant

Resistente al fuoco



Porcelain tiles are not flammable, reduce the spread of flames, do not burn, and do not emit toxic fumes.

Le piastrelle in gres porcellanato non sono infiammabili, riducono la propagazione della fiamma, non bruciano e non emettono fumi tossici.

Heat resistant

Resistente al calore



Porcelain tiles do not change shape at high temperatures.

Il gres porcellanato non si altera alle alte temperature.

Environment

AMBIENTE

Energy efficiency

Efficienza energetica



The high thermal inertia of porcelain tiles moderates the changes in temperature of the rooms, favoring energy savings.

L'elevata inerzia termica del gres porcellanato modera gli sbalzi di temperatura degli ambienti, favorendo il risparmio energetico.

Ecological

Ecologico



Porcelain tiles have a low environmental impact at all stages of their production, from the raw materials to disposal and recycling.

Il gres porcellanato ha un basso impatto ambientale in tutte le fasi del suo processo industriale, dalle materie prime fino allo smaltimento e al riciclo.

Recycling and re-use

Riciclo e riutilizzo



Porcelain tiles are made with recycled materials, last a long time, and can be re-used because they retain their original appearance.

Il gres porcellanato è realizzato con materiali di riciclo, dura a lungo e mantenendo l'aspetto originario può essere riciclato.

Ideal for floor heating systems

Ideale per sistemi di riscaldamento a pavimento



Porcelain tiles can be effectively combined with floor heating systems.

Il gres porcellanato può essere abbinato in modo efficace a sistemi di riscaldamento a pavimento.

WALL TILES ADDITIONAL BENEFITS

PROPRIETÀ CERAMICA
DA RIVESTIMENTO

Ease of installation

Facilità di lavorazione



Cuts, holes, and bevels are easily made and reduce the time it takes to lay the white body tiles.

Tagli, fori, bisellature sono facili da realizzare e rendono più veloce la posa dei rivestimenti in pasta bianca.

Extremely easy to clean

Estrema facilità di pulizia



White body ceramic tiles can be cleaned with a simple passage of hot water or neutral detergent.

I rivestimenti ceramici in pasta bianca si puliscono con un semplice passaggio di acqua calda o detergente neutro.

While porcelain tiles are ideal for use on the floor thanks to their hardness and extreme durability, the light weight and workability of white body tiles make them ideal for use on walls: cuts and holes can be made quickly and easily, reducing installation time and costs.

Mentre il gres porcellanato è ideale per l'uso a pavimento, per la sua durezza e l'estrema resistenza, le caratteristiche di leggerezza e lavorabilità del rivestimento in pasta bianca lo rendono ideale per l'uso a parete: i tagli e i fori saranno eseguiti facilmente e velocemente, riducendo i tempi e i costi di posa.



INDEX

OVERVIEW

SPACES

RANGE

TECH. SPECS

LE GRÈS CÉRAME : LE CHOIX SÛR / DAS FEINSTEINZEUG: EINE SICHERE WAHL / GRES PORCELÁNICO: LA ELECCIÓN SEGURA / КЕРАМИКА: НАДЕЖНЫЙ ВЫБОР

Résistance et longévité / Widerstandsfähigkeit und Lebensdauer / Resistencia y durabilidad / Стойкость и долговечность

Résistance et longévité / Widerstandsfähigkeit und Lebensdauer / Resistencia y durabilidad / Стойкость и долговечность

Entretien facile / Leicht zu warten / Fácil de mantener / Простота ухода

Entretien facile / Leicht zu warten / Fácil de mantener / Простота ухода

Le grès cérame n'exige aucun entretien particulier. / Feinsteinzeug erfordert keine besonderen Wartungsarbeiten. / El gres porcelánico no requiere particulares operaciones de mantenimiento. / Керамогранит не нуждается в особом уходе.

Résistant aux rayons UV / UV-Strahlenfest / Resistente a los rayos UV / Стойкость к УФ-излучению

Les coloris du grès cérame restent inaltérés même s'il est exposé à la lumière directe et continue du soleil ou au contact du smog et des agents atmosphériques. / Die Farben des Feinsteinzeugs bleiben unverändert erhalten, auch wenn es direktem und ständigem Sonnenlicht, der Witterung oder Smog ausgesetzt ist. / El gres porcelánico no se altera con el paso del tiempo, tampoco cambia su color cuando está expuesto a la luz directa y continua del sol o cuando entra en contacto con agentes climatológicos o contaminación. / Керамогранит не выцветает даже при постоянном воздействии солнечного света, атмосферных факторов, смога.

Résistant aux rayures / Kratzfestigkeit / Resistente a las rayas / Стойкость к царапинам

Le grès cérame ne subit ni ébrêchures, ni cassures, ni dommages. / Feinsteinzeug splittert nicht, es zerbricht nicht und erleidet keine Beschädigungen. / El gres porcelánico no se desportilla, no se rompe y no se estropea. / Керамогранит не раскалывается, не ломается, не повреждается.

Facile à nettoyer / Leicht zu reinigen / De fácil limpieza / Легкость чистки

Le grès cérame se nettoie facilement. / Feinsteinzeug kann leicht gereinigt werden. / El gres porcelánico se limpia fácilmente. / Керамогранит легко очищается.

Résistant aux taches / Fleckenfestigkeit / Resistente a las manchas / Стойкость к пятнам

Le grès cérame est imperméable et aucun type de liquide ne peut endommager sa surface. / Feinsteinzeug ist wasserundurchlässig und Flüssigkeiten jeglicher Art können seine Oberfläche nicht beschädigen. / El gres porcelánico es impermeable y ningún tipo de líquido puede estropear la superficie. / Керамогранит непроницаем, и никакая жидкость не может повредить его поверхность.

Résistant aux agents chimiques / Beständigkeit gegen Chemikalien / Resistente a los agentes químicos / Стойкость к химическим веществам

Le grès cérame ne se tache pas et résiste aux agents chimiques les plus agressifs. / Feinsteinzeug ist fleckenfest und beständig gegen die aggressivsten Chemikalien. / El gres porcelánico no se mancha y es resistente a los agentes químicos más agresivos. / Даже самые агрессивные химикаты не повреждают керамогранит и не оставляют на нем пятен.

Résistant aux acides / Beständigkeit gegen säuren / Resistente a los ácidos / Стойкость к кислотам

Le grès cérame résiste aux acides d'usage alimentaire et domestique. / Feinsteinzeug ist beständig gegen Säuren, die in Nahrungsmitteln oder im Haushalt verwendet werden. / El gres porcelánico es resistente a los ácidos de uso alimenticio y doméstico. / Керамогранит устойчив к кислотам, входящим в состав пищевых продуктов и средств бытовой химии.

Résistant aux écarts thermiques / Beständigkeit gegen thermoschocks / Resistente a los choques térmicos / Стойкость к перепадам температур

Résistant à l'eau / Wasserfestigkeit / Resistente al agua / Стойкость к воде

Résistant aux écarts thermiques / Beständigkeit gegen thermoschocks / Resistente a los choques térmicos / Стойкость к перепадам температур

Un sol en grès cérame ne subit aucune altération suite aux écarts thermiques. / Ein Feinsteinzeug-Fußboden wird von Temperaturschwankungen nicht beeinträchtigt. / El pavimento de gres porcelánico no cambia a causa de cambios bruscos de temperatura. / Напольные покрытия из керамогранита не разрушаются при перепадах температуры.

Résistant à l'eau / Wasserfestigkeit / Resistente al agua / Стойкость к воде

Le grès cérame est absolument non poreux et ne craint ni l'eau ni l'humidité. / Feinsteinzeug ist absolut porös und fürchtet weder Wasser noch Feuchtigkeit. / El gres porcelánico no es poroso, no le penetra el agua y es resistente a la humedad. / Керамогранит – абсолютно непористый материал, поэтому не боится воды и влаги.

Résistant au gel / Frostbeständigkeit / Resistente a las heladas / Стойкость к морозам

Le grès cérame est îngélif et résiste aux températures les plus basses. / Feinsteinzeug ist frostbeständig und widersteht den niedrigsten Temperaturen. / El gres porcelánico es resistente a las heladas y a las bajas temperaturas. / Керамогранит способен противостоять морозам и низким температурам.

Santé / Gesundheit / Salud / Здоровье

Zéro allergène / Null allergene / Cero alérgenos / Ноль аллергенов

Zéro allergène / Null allergene / Cero alérgenos / Ноль аллергенов

Le grès cérame est inhospitalier vis-à-vis des acariens, bactéries, champignons, moisissures et autres substances irritantes. / Feinsteinzeug ist unangstlich für Milben, Bakterien, Pilze, Schimmel und andere Reizstoffe. / El gres porcelánico es inhóspito para los ácaros, bacterias, hongos, mohos y otras sustancias irritantes. / На поверхности керамогранита не накапливаются клещи, бактерии, грибки, плесень и другие болезнетворные микроорганизмы.

Zéro COV / Null VOC / Cero VOC / Ноль летучих органических соединений

Les carreaux en grès cérame sont intrinsèquement inorganiques et ne libèrent aucun composé organique volatil. / Feinsteinzeugfliesen sind von Natur aus anorganisch und setzen keine flüchtigen organischen Verbindungen frei. / Las baldosas de gres porcelánico son intrínsecamente inorgánicas y no emiten compuestos orgánicos volátiles. / Керамогранит является неорганическим материалом и не выделяет летучих органических соединений.

Zéro formaldéhyde / Null formaldehyd / Cero formaldehído / Ноль формальдегида

Le grès cérame ne contient pas de formaldéhyde. / Feinsteinzeug ist formaldehydfrei. / El gres porcelánico non contiene formaldehído. / Керамогранит не содержит формальдегид.

Zéro PVC / Null PVC / Cero PVC / Ноль ПВХ

Résistant à la croissance bactérienne / Vorbeugung gegen das Wachstum von Bakterien / Previene la proliferación de bacterias / Предотвращение развития бактерий

Résistant à la croissance bactérienne / Vorbeugung gegen das Wachstum von Bakterien / Previene la proliferación de bacterias / Предотвращение развития бактерий

Résistant à la croissance bactérienne / Vorbeugung gegen das Wachstum von Bakterien / Previene la proliferación de bacterias / Предотвращение развития бактерий

Il prévient la croissance bactérienne / Vorbeugung gegen das Wachstum von Bakterien / Previene la proliferación de bacterias / Предотвращение развития бактерий

Le grès cérame est absolument hygiénique et inhospitalier vis-à-vis des bactéries, acariens, moisissures et champignons. / Feinsteinzeug ist absolut hygienisch und unangstlich für Bakterien, Milben, Schimmel und Pilze. / El gres porcelánico es totalmente higiénico e inhóspito para las bacterias, ácaros, mohos y hongos. / Керамогранит абсолютно гигиеничен и препятствует развитию бактерий, клещей, плесени, грибка.

Sécurité / Sicherheit / Seguridad / Безопасность

Résistant au feu / Feuerfestigkeit / Resistente al fuego / Огнестойкость

Résistant au feu / Feuerfestigkeit / Resistente al fuego / Огнестойкость

Antiglisse / Rutschfestigkeit / Antideslizante / Препятствование скольжению

Les surfaces en grès cérame peuvent être réalisées avec un fond superficiel abrasif en mesure d'augmenter la traction et réduire le risque de glissade. / Die Oberflächen des Feinsteinzeugs können mit die Reibung erhöhenden Splitten bereichert werden, welche die Trittsicherheit verbessern und die Gefahr von Ausrutschern mindern. / Las superficies de gres porcelánico se fabrican con una granalla abrasiva superficial en grado de aumentar la tracción y reducir los riesgos de deslizamiento. / На поверхность керамогранитной плитки в процессе изготовления может наноситься специальная абразивная крошка, которая увеличивает сцепление и снижает риск скольжения.

Résistant au feu / Feuerfestigkeit / Resistente al fuego / Огнестойкость

Les carreaux en grès cérame sont ininflammables, ils réduisent la propagation de la flamme, ne brûlent pas et de libèrent aucune fumée toxique. / Feinsteinzfliesen sind nicht entflammbar, sie mindern die Flammenausbreitung, brennen nicht und setzen keinen toxischen Rauch frei. / Las baldosas de gres porcelánico no son inflamables, reducen la propagación de las llamas, son resistentes al fuego y no emiten humos tóxicos. / Керамогранитная плитка не воспламеняется, ограничивает распространение огня, не горит, не выделяет токсичного дыма.

Résistant à la chaleur / Wärmebeständigkeit / Resistente al calor / Термостойкость

Le grès ne subit aucune altération aux températures élevées. / Feinsteinzeug wird von hohen Temperaturen nicht verändert. / El gres porcelánico no se altera con las altas temperaturas. / Керамогранит не повреждается под действием высоких температур.

Environnement / Umwelt / Ambiente / Окружающая среда

Efficacité énergétique / Energieeffizienz / Eficiencia energética / Энергоэффективность

Efficacité énergétique / Energieeffizienz / Eficiencia energética / Энергоэффективность

La haute inertie thermique du grès cérame modère les écarts de température à l'intérieur des pièces, en favorisant ainsi les économies d'énergie. / Die hohe Wärmeträgheit des Feinsteinzeugs reduziert starke Temperaturschwankungen in den Räumen und ermöglicht demzufolge eine Energieeinsparung. / La elevada inercia térmica del gres porcelánico modera los cambios de temperatura de los ambientes, favoreciendo el ahorro energético. / Высокая тепловая инерция керамогранита сглаживает колебания температуры в помещении, что позволяет значительно экономить энергию.

Écologique / Ökologisch / Ecológico / Экологичность

Le grès cérame a un faible impact sur l'environnement durant toutes les phases de son processus industriel, à partir des matières premières jusqu'à l'élimination et au recyclage. / In allen Phasen seines Herstellungsprozesses verursacht das Feinsteinzeug eine geringfügige Umweltbelastung, angefangen beim Abbau der Rohstoffe bis zur Entsorgung und zum Recycling. / El gres porcelánico tiene un bajo impacto ambiental en todas las fases de su proceso industrial, dese las materias primas hasta la eliminación y el reciclaje. / Керамогранит имеет низкое воздействие на окружающую среду на всем протяжении жизненного цикла: от добычи сырья до переработки и утилизации.

Recyclage et réutilisation / Recycling und wiederverwertung / Reciclaje y reutilización / Переработка и утилизация

Le grès cérame est fabriqué avec des matériaux de recyclage, il dure longtemps en maintenant son aspect d'origine et il est recyclable. / Feinsteinzeug wird aus Recycling-Material hergestellt, hat eine lange Lebensdauer, erhält sein ursprüngliches Aussehen und kann recycelt werden. / El gres porcelánico está fabricado con materiales de reciclado, es duradero al paso del tiempo y se puede reciclar manteniendo el aspecto original. / Керамогранит изготавливается из переработанных материалов, долговечен, сохраняет во времени свои первоначальные характеристики и поддается переработке.

Idéal pour les systèmes de chauffage au sol / Ideal für fussbodenheizsysteme / Indicado para los sistemas de calefacción por suelo radiante / Идеальное решение для теплого пола

Le grès cérame peut être associé de manière efficace à des systèmes de chauffage au sol. / Feinsteinzeug ist optimal leistungsfähig in Verbindung mit Fußbodenheizsystemen. / El gres porcelánico se puede utilizar eficazmente con sistemas de calefacción por suelo radiante. / Керамогранит отлично подходит для облицовки полов с подогревом.

PROPRIÉTÉS DE LA CÉRAMIQUE POUR REVÊTEMENTS / EIGENSCHAFTEN DER WANDFLIESEN / CARACTERÍSTICAS Y BENEFICIOS DE LA CERÁMICA PARA REVESTIMIENTO / СВОЙСТВА КЕРАМИЧЕСКОЙ ПЛИТКИ

Tandis que le grès cérame est idéal pour l'usage au sol en raison de sa dureté et de son extrême résistance, les caractéristiques de légèreté et d'usinabilité des carreaux en pâte blanche en font l'idéal pour l'usage mural : les découpes et les perçages s'effectuent facilement et rapidement, en réduisant les temps et les coûts de la pose. / Während das Feinsteinzeug dank seiner Härte und extremen Widerstandsfähigkeit ideal für die Fußbodenverlegung ist, machen die Leichtigkeit und die Verarbeitungsfreundlichkeit der weißscherbigen Wandbeläge diese ideal für Wandverlegungen: Schnitte und Bohrungen werden leicht und schnell ausgeführt, wodurch die Verlegungszeiten und -kosten sich verringern. / Si bien el gres porcelánico es indicado para su uso en pavimentos, por su dureza y máxima resistencia, el revestimiento de pasta blanca es indicado para su uso en paredes por sus propiedades de ligereza y facilidad de trabajo: se consigue una mejor facilidad y rapidez de cortes y perforación, reduciendo los tiempos y costes de colocación. / Если керамогранит, в силу своей твердости и стойкости, особенно рекомендован для полов, то такие характеристики, как небольшой вес и высокая обрабатываемость, делают плитку из белой глины идеальной для монтажа на стену: легкость и быстрота резки и сверления снижают затраты времени и денег на укладку.

Facilité de travail / Verarbeitungsfreundlichkeit / Fácil de trabajar / Легкость обработки

Les découpes, les perçages et les biseautages sont faciles à réaliser et rendent plus rapide la pose des carrelages en pâte blanche. / Schnitte, Bohrungen, Abkantungen sind leicht zu verwirklichen, daher können weißscherbige Keramikbeläge überall schneller verlegt werden. / Cortes, perforaciones y biselados se realizan fácilmente y la instalación de los revestimientos de pasta blanca se hace con rapidez. / Легкость резки, сверления, скашивания граней ускоряет процесс укладки настенной плитки из белой глины.

Nettoyage extrêmement facile / Extrem einfache Reinigung / Máxima facilidad de limpieza / Предельная простота ухода

Les carrelages céramiques en pâte blanche se nettoient simplement avec de l'eau chaude ou avec un détergent neutre. / Die weißscherbigen Keramikbeläge werden einfach durch Abwischen mit warmem Wasser oder einem neutralen Putzmittel gereinigt. / Los revestimientos cerámicos de pasta blanca se limpian pasando un trapo húmedo con agua caliente o detergente neutro. / Настенная плитка из белой глины очищается теплой водой или нейтральным моющим средством.

INDEX

OVERVIEW

SPACES

RANGE

TECH. SPECS

White-body wall tiles - Rectified monocaliber

Rivestimenti in pasta bianca - Rettificato monocalibro



Compliant with standards EN 14411 annex L group BIII
Compliant with standards ISO 13006 annex L group BIII
Conforme alla norma EN 14411 Appendice L gruppo BIII
Conforme alla norma ISO 13006 Appendice L gruppo BIII

50x120 cm - 19 5/8"x47 1/4" ± 8,5 mm

Technical features Caratteristiche tecniche	Test Method Metodo di prova	Requirements for nominal size N Requisiti per dimensione nominale N		
		7 cm ≤ N < 15 cm	N ≥ 15 cm	
		(mm)	(%)	(mm)
Length and width Lunghezza e larghezza	ISO 10545-2	± 0,4 (*) Rect.	± 0,3 (*) Rect.	± 1,0 (*) Rect.
Thickness Spessore		± 0,5 (**)	± 10 (**)	± 0,5 (**)
Straightness of sides Rettilineità degli spigoli		± 0,4 (***) Rect.	± 0,3 (***) Rect.	± 0,8 (***) Rect.
Rectangularity Ortogonalità		± 0,4 (****) Rect.	± 0,3 (****) Rect.	± 1,5 (****) Rect.
Surface flatness Planarità	ISO 10545-2	c.c. ± 0,6 Rect. e.c. ± 0,6 Rect. w. ± 0,6 Rect.	c.c. ± 0,4 Rect. e.c. ± 0,4 Rect. w. ± 0,4 Rect.	c.c. ± 1,8 Rect. e.c. ± 1,8 Rect. w. ± 1,8 Rect.
Water absorption (in % by mass) Massa d'acqua assorbita (come % della massa)	ISO 10545-3	Average >10%. When the average > 20%, this shall be indicated. Individual value > 9% Media >10%. Se questo valore > 20%, deve essere indicato. Valore Singolo > 9%		
Breaking strength Sforzo di rottura	ISO 10545-4	S ≥ 600 N		
Modulus of rupture Resistenza alla flessione		R ≥ 15 N/mm ²		
Coefficient of thermal linear expansion Coefficiente di dilatazione termica lineare	ISO 10545-8	Declared value Valore dichiarato		
Thermal shock resistance Resistenza agli sbalzi termici	ISO 10545-9	Pass according to EN ISO 10545-1 Test superato in accordo con ISO 10545-1		
Moisture expansion (in mm/m) Dilatazione all'umidità (in mm/m)	ISO 10545-10	Declared value Valore dichiarato		
Crazing resistance Resistenza al cavillo	ISO 10545-11	Pass according to EN ISO 10545-1 Test superato in accordo con ISO 10545-1		
Bond strength/adhesion for improved cementitious adhesives Adesione a trazione con adesivi cementizi migliorati	EN 1348	Declared value Valore dichiarato		
Reaction to fire Reazione al fuoco	-	Class A1 Classe A1		
Resistance to household chemicals and swimming pool salts Resistenza ai prodotti chimici di uso domestico ed agli additivi per piscina	ISO 10545-13	Minimum Class B Classe minima B		
Resistance to low concentrations of acids and alkalis Resistenza a basse concentrazioni di acidi e alcali		Declared Class Classe dichiarata		
Resistance to high concentrations of acids and alkalis Resistenza ad alte concentrazioni di acidi e alcali		Declared Class Classe dichiarata		
Resistance to staining, for unglazed tiles Resistenza alle macchie per piastrelle non smaltate	ISO 10545-14	Minimum Class 3 Classe 3 minima		
Release of dangerous substances: Cadmium (in mg/dm²) and Lead (in mg/dm²) Rilascio di sostanze pericolose: Cadmio (in mg/dm ²) e Piombo (in mg/dm ²)	ISO 10545-15	Declared value Valore dichiarato		

*) The permissible deviation, in % or mm, of the average size for each tile (2 or 4 sides) from work size (WS). Deviazione ammissibile, in % oppure mm, della dimensione media di ogni piastrella (2 oppure 4 lati) dalla dimensione di fabbricazione (WS).
 **) The permissible deviation, in % or mm, of the average thickness for each tile from the work size thickness (WS). Deviazione ammissibile, in % oppure mm, dello spessore medio di ogni piastrella dallo spessore riportato nella dimensione di fabbricazione (WS).
 ***) The maximum permissible deviation from straightness, in % or mm, related to the corresponding work sizes (WS). Deviazione massima ammissibile di rettilineità, in % oppure mm, in rapporto alle dimensioni di fabbricazione (WS) corrispondenti.
 ****) The maximum permissible deviation from rectangularity, in % or mm, related to the corresponding work sizes (WS). Deviazione massima ammissibile di ortogonalità, in % oppure mm, in rapporto alle dimensioni di fabbricazione (WS) corrispondenti.
 c.c. The maximum permissible deviation from centre curvature, in % or mm, related to diagonal calculated from the work sizes (WS). Deviazione massima ammissibile della curvatura del centro, in % oppure mm, in rapporto alla diagonale calcolata secondo le dimensioni di fabbricazione (WS).
 e.c. The maximum permissible deviation from edge curvature, in % or mm, related to the corresponding work sizes (WS). Deviazione massima ammissibile della curvatura dello spigolo, in % oppure mm, in rapporto alle dimensioni di fabbricazione (WS) corrispondenti.
 w. The maximum permissible deviation from warpage, in % or mm, related to diagonal calculated from the work sizes (WS). Deviazione massima ammissibile dello svergolamento, in % oppure mm, in rapporto alla diagonale calcolata secondo le dimensioni di fabbricazione (WS).

Coloured body porcelain tiles - Rectified monocaliber

Gres porcellanato colorato in massa - Rettificato monocalibro



Compliant with standards EN 14411 annex G group BII
Compliant with standards ISO 13006 annex G group BII
Conforme alla norma EN 14411 Appendice G gruppo BII
Conforme alla norma ISO 13006 Appendice G gruppo BII

120x278 cm - 47 1/4"x109 1/2"
120x120 cm - 47 1/4"x47 1/4"
60x120 cm - 23 3/8"x47 1/4"
± 6 mm
± 9 mm
± 9 mm

60x60 cm - 23 3/8"x23 3/8"
30x60 cm - 11 1/4"x23 3/8"
120x120 cm - 47 1/4"x47 1/4"
80x80 cm - 31 1/2"x31 1/2"
± 9 mm
± 9 mm
± 20 mm
± 20 mm

Technical features Caratteristiche tecniche	Test Method Metodo di prova	Requirements for nominal size N / Requisiti per dimensione nominale N				
		7 cm ≤ N < 15 cm		N ≥ 15 cm		
		MM	(%)	(mm)		
Length and width Lunghezza e larghezza	ISO 10545-2	± 0,9 (*) Non-rect. ± 0,4 (*) Rect.	± 0,6 (*) Non-rect. ± 0,3 (*) Rect.	± 2,0 (*) Non-rect. ± 1,0 (*) Rect.		
Thickness Spessore		± 0,5 (**)	± 5 (**)	± 0,5 (**)		
Straightness of sides Rettilineità degli spigoli		± 0,8 (***) Non-rect. ± 0,4 (***) Rect.	± 0,5 (***) Non-rect. ± 0,3 (***) Rect.	± 1,5 (***) Non-rect. ± 0,8 (***) Rect.		
Rectangularity (Measurement only on short edges when L/l ≥ 3) Ortogonalità (Misurazione da condurre solo sui lati corti quando L/l ≥ 3)		± 0,8 (****) Non-rect. ± 0,4 (****) Rect.	± 0,5 (****) Non-rect. ± 0,3 (****) Rect.	± 2,0 (****) Non-rect. ± 1,5 (****) Rect.		
Surface flatness Planarità	ISO 10545-2	c.c. ± 0,8 Non-rect. c.c. ± 0,6 Rect. e.c. ± 0,8 Non-rect. e.c. ± 0,6 Rect. w. ± 0,8 Non-rect. w. ± 0,6 Rect.	c.c. ± 0,5 Non-rect. c.c. ± 0,4 Rect. e.c. ± 0,5 Non-rect. e.c. ± 0,4 Rect. w. ± 0,5 Non-rect. w. ± 0,4 Rect.	c.c. ± 2,0 Non-rect. c.c. ± 1,8 Rect. e.c. ± 2,0 Non-rect. e.c. ± 1,8 Rect. w. ± 2,0 Non-rect. w. ± 1,8 Rect.		
Water absorption (in % by mass) Massa d'acqua assorbita (come % della massa)	ISO 10545-3 ASTM C373-18	E _v ≤ 0,5% Individual Maximum 0,6% E _v ≤ 0,5% Valore massimo singolo 0,6%			Requirement ANSI A137.1-2017 Water absorption max ≤ 0,5%	
Breaking strength Sforzo di rottura	ISO 10545-4	S ≥ 700N (for thickness < 7,5 mm - per spessore < 7,5 mm) S ≥ 1300N (for thickness ≥ 7,5 mm - per spessore ≥ 7,5 mm)			S ≥ 1500 N	
Modulus of rupture Resistenza alla flessione	EN 1339 Annex F	R ≥ 35 N/mm ²			S ≥ 1000 N	
Bending strength and breaking load Resistenza a flessione e al carico di rottura (4)/(5)		-			S ≥ 1500 N	
Impact resistance, as coefficient of restitution Resistenza all'impatto, espresso come coefficiente di restituzione	ISO 10545-5	Declared value Valore dichiarato			S ≥ 1500 N	
Mohs hardness Durezza Mohs	EN 101	-			S ≥ 1500 N	
Resistance to deep abrasion of unglazed tiles (removed volume) Resistenza all'abrasione profonda delle piastrelle non smaltate (volume materiale asportato)	ISO 10545-6	≤ 175 mm ³			S ≥ 1500 N	
Coefficient of thermal linear expansion Coefficiente di dilatazione termica lineare	ISO 10545-8	Declared value Valore dichiarato			S ≥ 1000 N	
Thermal shock resistance Resistenza agli sbalzi termici	ISO 10545-9	Pass according to EN ISO 10545-1 Test superato in accordo con ISO 10545-1			S ≥ 1500 N	
Moisture expansion (in mm/m) Dilatazione all'umidità (in mm/m)	ISO 10545-10	Declared value Valore dichiarato			S ≥ 1500 N	
Frost resistance Resistenza al gelo	ISO 10545-12	Pass according to EN ISO 10545-1 Test superato in accordo con ISO 10545-1			S ≥ 1500 N	
Bond strength/adhesion for improved cementitious adhesives Adesione a trazione con adesivi cementizi migliorati	EN 1348	Declared value Valore dichiarato			S ≥ 1500 N	
Reaction to fire Reazione al fuoco	-	Class A1 or A1 _{fl} Classe A1 oppure A1 _{fl}			S ≥ 1500 N	
Resistance to household chemicals and swimming pool salts Resistenza ai prodotti chimici di uso domestico e agli additivi per piscina	ISO 10545-13	Minimum Class B Classe minima B			S ≥ 1000 N	
Resistance to low concentrations of acids and alkalis Resistenza a basse concentrazioni di acidi e alcali		Declared Class Classe dichiarata			S ≥ 1500 N	
Resistance to high concentrations of acids and alkalis Resistenza ad alte concentrazioni di acidi e alcali		Declared Class Classe dichiarata			S ≥ 1500 N	
Resistance to staining, for unglazed tiles Resistenza alle macchie per piastrelle non smaltate	ISO 10545-14	Declared Class Classe dichiarata			S ≥ 1500 N	
Shod Ramp Test Metodo della rampa "calzato"	DIN 51130	Declared value Valore dichiarato			R10	
Barefoot Ramp Test Metodo della rampa a piedi nudi	DIN 51097	Declared value Valore dichiarato			R9	
Pendulum Friction Test Metodo del Pendolo (1)(2)	BS 7976	PTV ≥ 36 classifies the surface as "low slip risk"			0	
	AS 4586	Declared Classification of the new pedestrian surface materials according to the Pendulum Test			A+B+C	
	UNE-ENV 12633	Declared value Valore dichiarato			A	
Coefficient of friction (COF) Coefficiente di attrito	B.C.R.A. Rep. CEC/81	D. M. 236/89 del 14/06/89 μ > 0,40 per elemento scivolante ruotolo su pavimentazione asciutta μ > 0,40 per elemento scivolante gomma dura su pavimentazione bagnata			A+B+C	
Dynamic coefficient of friction (DCOF) Coefficiente di attrito dinamico	ANSI A137.1	ANSI A.137.1-2017 Requires a minimum value of 0.42 for level interior space expected to be walked upon when wet. (3)			A+B+C	

*) The permissible deviation, in % or mm, of the average size for each tile (2 or 4 sides) from work size (WS). Deviazione ammissibile, in % oppure mm, della dimensione media di ogni piastrella (2 oppure 4 lati) dalla dimensione di fabbricazione (WS).
 **) The permissible deviation, in % or mm, of the average thickness for each tile from the work size thickness (WS). Deviazione ammissibile, in % oppure mm, dello spessore medio di ogni piastrella dallo spessore riportato nella dimensione di fabbricazione (WS).
 ***) The maximum permissible deviation from straightness, in % or mm, related to the corresponding work sizes (WS). Deviazione massima ammissibile di rettilineità, in % oppure mm, in rapporto alle dimensioni di fabbricazione (WS) corrispondenti.
 ****) The maximum permissible deviation from rectangularity, in % or mm, related to the corresponding work sizes (WS). Deviazione massima ammissibile di ortogonalità, in % oppure mm, in rapporto alle dimensioni di fabbricazione (WS) corrispondenti.
 c.c. The maximum permissible deviation from centre curvature, in % or mm, related to diagonal calculated from the work sizes (WS). Deviazione massima ammissibile della curvatura del centro, in % oppure mm, in rapporto alla diagonale calcolata secondo le dimensioni di fabbricazione (WS).
 e.c. The maximum permissible deviation from edge curvature, in % or mm, related to the corresponding work sizes (WS). Deviazione massima ammissibile della curvatura dello spigolo, in % oppure mm, in rapporto alle dimensioni di fabbricazione (WS) corrispondenti.
 w. The maximum permissible deviation from warpage, in % or mm, related to diagonal calculated from the work sizes (WS). Deviazione massima ammissibile dello svergolamento, in % oppure mm, in rapporto alla diagonale calcolata secondo le dimensioni di fabbricazione (WS).
 (1). Determination of slip resistance of pedestrian surfaces; it does not cover sports surfaces and road surfaces for vehicles (skid resistance). Determinazione della resistenza allo scivolamento delle superfici pedonabili; non si applica alle pavimentazioni sportive ed alle pavimentazioni stradali veicolate.
 (2). Anti-slip performance is guaranteed at the time of delivery of the product. Le prestazioni anti-slip vengono garantite al momento della consegna del prodotto.
 (3). However, tiles with a DCOF of 0.42 or greater are not necessarily suitable for all projects. The specifier shall determine tiles appropriate for specific project conditions, considering by way of example, but not in limitation, type of use, traffic, expected contaminants, expected maintenance, expected wear, and manufacturers' guidelines and recommendations.
 ● PTV ≥ 36 Wet on demand / su richiesta
 ●● P3 on demand / su richiesta
 ●●● C2 on demand / su richiesta

INDEX

OVERVIEW

SPACES

RANGE

TECH. SPECS



GRANITI VICENTIA
GROUP

2135 State Highway 6 South
Houston, Texas 77077

Phone: +1 713-869-0800

www.granitivicentia.com
info@granitivicentia.com



GRANITI VICENTIA
GROUP



GRANITI VICENTIA

GROUP