

NOVA

**VARIAZIONI
SUL TEMA**

*VARIATIONS
ON A THEME*



LEA
CERAMICHE

UNA NUOVA
SPERIMENTAZIONE
SULLA MATERIA
CERAMICA.

New experiments
on ceramic
material.

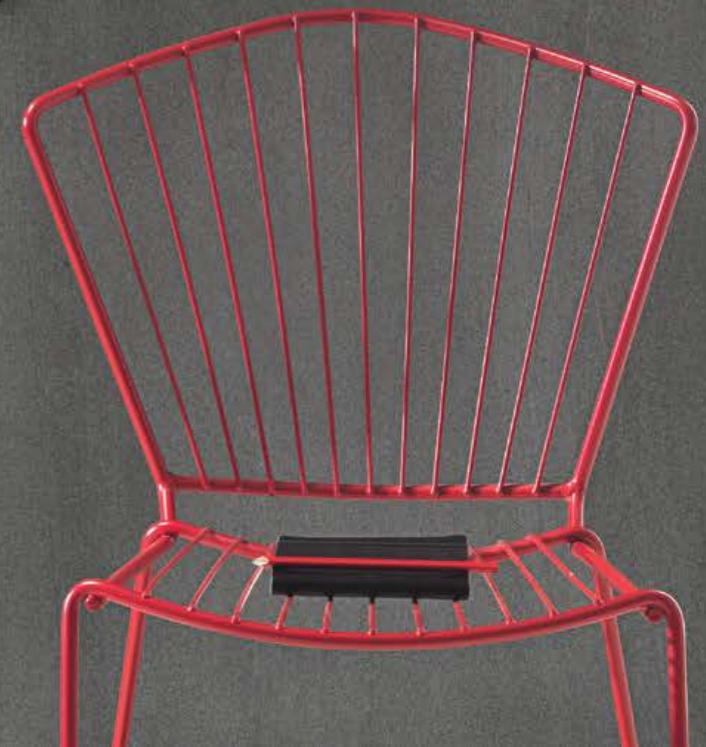

PUBLIC AREAS



Buga, Antoni Gaudí,
Joaquín Torres-García,
by Danny McDonald,
by Saul Steinberg.

... drawings of Saul Steinberg
... and other drawings
... natural elements, water, clouds,
... and a variety of objects
... by the artist, and the
... and Steinberg had to
... management and
... whether they are selected
... 2003 work.

... of Space, created with
... Contemporary Art Society
... SculptureCenter's
... Society.



**NOVA
TAUPE SHINE**

Pavimento / Floor
nat. rett. 60x120cm / 24"x48"



NOVA
TAUPE SHINE

Pavimento / Floor
nat. rett. 60x60cm / 24"x24"



Markham Photographers
BEYOND THE FA



BEYOND THE FALL AN



PUBLIC AREAS

Prodotta in 3 formati con una varietà cromatica prevalentemente neutra, che la rende contemporanea e classica allo stesso tempo, si adatta a qualsiasi stile ed ambiente. Una naturale eleganza.

Available in 3 sizes, with neutral colours that are both contemporary and classic, this collection is ideal for any environment. Natural elegance.

NOVA SILVER RAY

Parete / Wall
nat. rett. 30x60cm / 12"x24"
Pavimento / Floor
nat. rett. 60x60cm / 24"x24"

OUTDOOR

**NOVA
CINDER FLASH**

Pavimento / Floor
nat. rett. 60x60cm / 24"x24"
grip rett. 60x60cm / 24"x24"



**NOVA
CINDER FLASH**

Pavimento / Floor
grip rett. 60x60cm / 24"x24"

**Leggeri movimenti e delicate
venature resi mediante la sempre
più affinata tecnica di stampa
digitale, caratterizzano Nova, la
nuova collezione di Lea Ceramiche.**

**Subtle motion and delicate veins,
created by means of the digital printing
technique, characterise Nova, the new
collection by Lea Ceramiche.**

NOVA
CINDER FLASH

Pavimento / Floor
nat. rett. 60x60cm / 24"x24"

LIVING



NOVA
BEIGE STREAM

Pavimento / Floor
nat. rett. 60x120cm / 24"x48"

SHOP



**NOVA
BEIGE STREAM**

Pavimento / Floor
nat. rett. 60x120cm / 24"x48"

NOVA
BEIGE STREAM

Pavimento / Floor
nat. rett. 60x120cm / 24"x48"





NOVA
TAUPE SHINE

Pavimento / Floor
nat. rett. 60x120cm / 24"x48"

LIVING

NOVA TAUPE SHINE

Pavimento / Floor
nat. rett. 60x60cm / 24"x24"



NOVA
GREY BURST

Pavimento / Floor
nat. rett. 60x60cm / 24"x24"





**NOVA
GREY BURST**

Pavimento / Floor
nat. rett. 60x60cm / 24"x24"

BEIGE STREAM

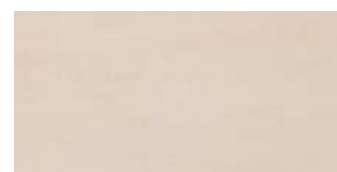

30x60cm / 12"x24"
nat. rett. LGVNO40
grip rett. LGVNO45



60x60cm / 24"x24"
nat. rett. LGWNO40
grip rett. LGWNOG4



30x120cm / 12"x48"
nat. rett. LG6NO40



60x120cm / 24"x48"
nat. rett. LGXNO41



*15x15cm / 6"x6"
nat. rett. LGINO40

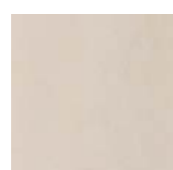

*30x30cm / 12"x12"
nat. rett. LGCNO40

CINDER FLASH

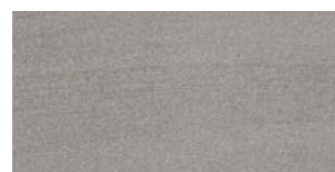

30x60cm / 12"x24"
nat. rett. LGVNO30
grip rett. LGVNO35



60x60cm / 24"x24"
nat. rett. LGWNO30
grip rett. LGWNOG3

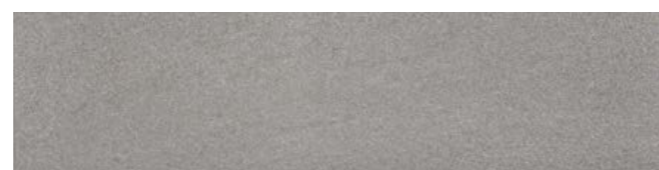

30x120cm / 12"x48"
nat. rett. LG6NO30



60x120cm / 24"x48"
nat. rett. LGXNO31



*15x15cm / 6"x6"
nat. rett. LGINO30

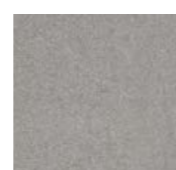

*30x30cm / 12"x12"
nat. rett. LGCNO30

TAUPE SHINE



30x60cm / 12"x24"
nat. rett. LGVNO20
grip rett. LGVNO25

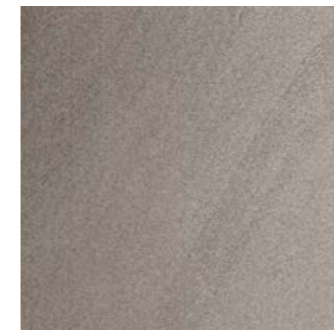

60x60cm / 24"x24"
nat. rett. LGWNO20
grip rett. LGWNOG2

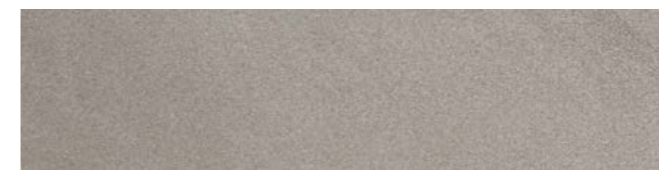

30x120cm / 12"x48"
nat. rett. LG6NO20



60x120cm / 24"x48"
nat. rett. LGXNO21



*15x15cm / 6"x6"
nat. rett. LGINO20



*30x30cm / 12"x12"
nat. rett. LGCNO20

SILVER RAY



30x60cm / 12"x24"
nat. rett. LGVNO10
grip rett. LGVNO15



60x60cm / 24"x24"
nat. rett. LGWNO10
grip rett. LGWNOG1

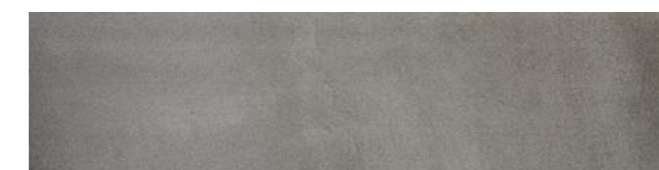

30x120cm / 12"x48"
nat. rett. LG6NO10



60x120cm / 24"x48"
nat. rett. LGXNO11



*15x15cm / 6"x6"
nat. rett. LGINO10



*30x30cm / 12"x12"
nat. rett. LGCNO10

*su richiesta. Per maggiori informazioni circa quantità minime e tempi di consegna rivolgersi all'ufficio commerciale.
upon request. For more information about minimum quantities and delivery times please contact the sales department.
sur demande. Pour plus d'informations sur les quantités minimales et délais de livraison s'il vous plaît contacter le département des ventes.
auf Anfrage. Für weitere Infos über die Mindestmengen und Lieferzeiten wenden Sie sich bitte an unserer Verkaufsabteilung.

FORMATI E COLORI

SIZES AND COLORS_FORMATS ET COULEURS_FORMATE UND FARBEN

DECORI

DECORS_DECORS_DEKORE

GREY BURST



30x60cm / 12"x24"
nat. rett.
grip rett.

LGVNO00
LGVNO05



60x60cm / 24"x24"
nat. rett.
grip rett.

LGWNO00
LGWNOG0



30x120cm / 12"x48"
nat. rett.

LG6NO00



60x120cm / 24"x48"
nat. rett.

LGXNO01



*15x15cm / 6"x6"
nat. rett. LGINO00



*30x30cm / 12"x12"
nat. rett. LGCNO00



MOSAICO GRAVITY
30x60cm / 12"x24"
taupe shine
cinder flash
silver ray
grey burst

LGVNO52
LGVNO53
LGVNO51
LGVNO50



MOSAICO 3D
28x28cm / 11"x11"
taupe shine
cinder flash
silver ray
grey burst

LGPNO20
LGPNO30
LGPNO10
LGPNO00



MOSAICO ANDROMEDA
20x30cm / 8"x12"
taupe shine
cinder flash
silver ray
grey burst

LGHNO20
LGHNO30
LGHNO10
LGHNO00

BACCHETTA METAL**
1,2x60cm / 1/2"x24"
blue ray
gold ray

LG9NO50
LG9NO51

**non trattato con antibatterico
without antimicrobial treatment
sans traitement antibacterien
nicht mit antibakterieller
Wirkung ausgestattet

NOVA SILVER RAY

Parete / Wall
nat. rett. 30x60cm / 12"x24"

*su richiesta. Per maggiori informazioni circa quantità minime e tempi di consegna rivolgersi all'ufficio commerciale.
upon request. For more information about minimum quantities and delivery times please contact the sales department.
sur demande. Pour plus d'informations sur les quantités minimales et délais de livraison s'il vous plaît contacter le département des ventes.
auf Anfrage. Für weitere Infos über die Mindestmengen und Lieferzeiten wenden Sie sich bitte an unserer Verkaufsabteilung.

NATURALE

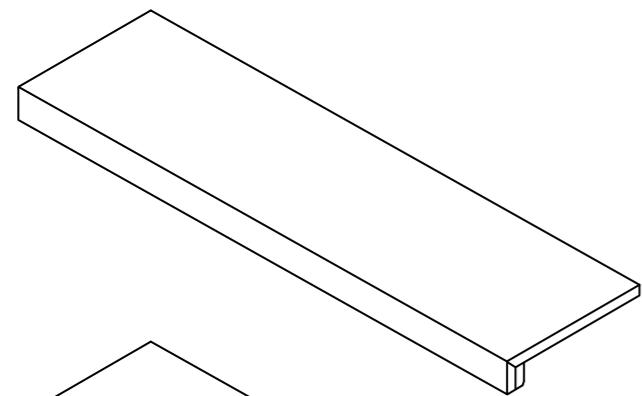

ANGOLO SX GRADINO PLUS nat. rett.*
35x120cm / 13^{3/4}"x48"
grey burst LG9NOS0
silver ray LG9NOS1
taupe shine LG9NOS2
cinder flash LG9NOS3
beige stream LG9NOS4

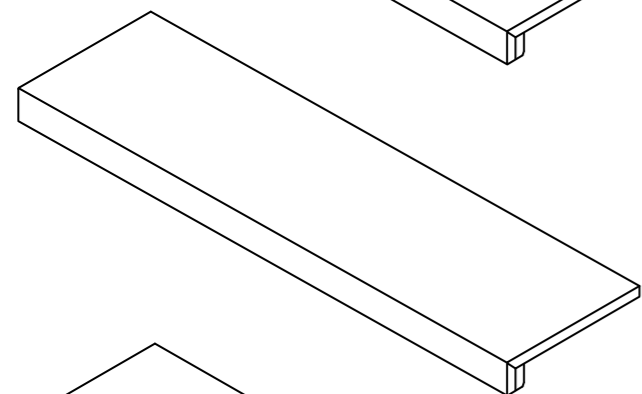

GRADINO PLUS nat. rett.*
35x120cm / 13^{3/4}"x48"
grey burst LG9NOP0
silver ray LG9NOP1
taupe shine LG9NOP2
cinder flash LG9NOP3
beige stream LG9NOP4

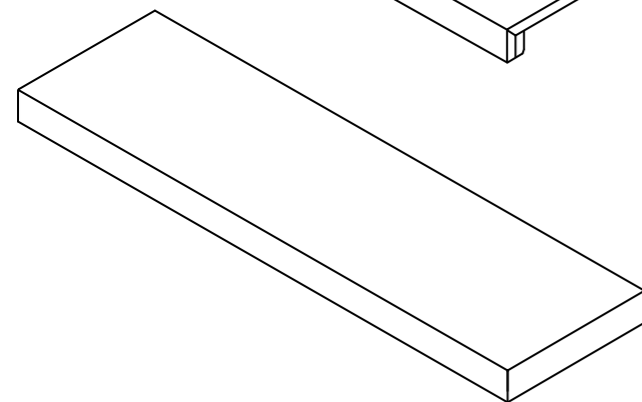

ANGOLO DX GRADINO PLUS nat. rett.*
35x120cm / 13^{3/4}"x48"
grey burst LG9NOD0
silver ray LG9NOD1
taupe shine LG9NOD2
cinder flash LG9NOD3
beige stream LG9NOD4

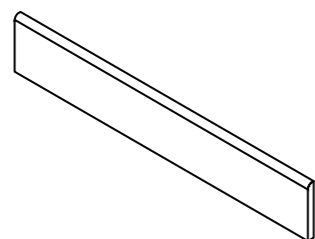

BATTISCOPA nat. rett.
10x60cm / 4"x24"
grey burst LGBNO00
silver ray LGBNO10
taupe shine LGBNO20
cinder flash LGBNO30
beige stream LGBNO40

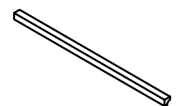

RACCORDO JOLLY nat.
1,3x30cm / 1/2"x12"
grey burst LG9NOR0
silver ray LG9NOR1
taupe shine LG9NOR2
cinder flash LG9NOR3
beige stream LG9NOR4



BEAK JOLLY nat.
1,3x2cm / 1/2"x3/4"
grey burst LG9NOJ0
silver ray LG9NOJ1
taupe shine LG9NOJ2
cinder flash LG9NOJ3
beige stream LG9NOJ4

GRIP

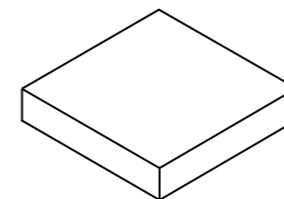

ANGOLO SX GRADINO PLUS grip rett.*
35x35cm / 13^{3/4}"x13^{3/4}"
grey burst LG9NO0S
silver ray LG9NO1S
taupe shine LG9NO2S
cinder flash LG9NO3S
beige stream LG9NO4S

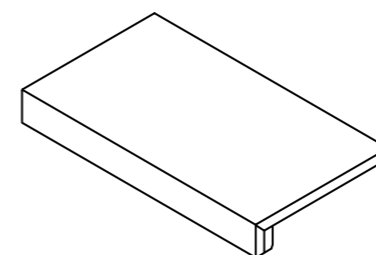

GRADINO PLUS grip rett.*
35x60cm / 13^{3/4}"x24"
grey burst LG9NO00
silver ray LG9NO10
taupe shine LG9NO20
cinder flash LG9NO30
beige stream LG9NO40

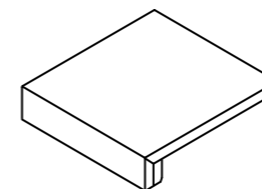

ANGOLO DX GRADINO PLUS grip*
35x35cm / 13^{3/4}"x13^{3/4}"
grey burst LG9NO0D
silver ray LG9NO1D
taupe shine LG9NO2D
cinder flash LG9NO3D
beige stream LG9NO4D

SEZIONE GRADINO

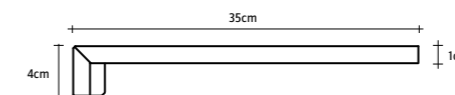

*su richiesta. Per maggiori informazioni circa quantità minime e tempi di consegna rivolgersi all'ufficio commerciale.
upon request. For more information about minimum quantities and delivery times please contact the sales department.
sur demande. Pour plus d'informations sur les quantités minimales et délais de livraison s'il vous plaît contacter le département des ventes.
auf Anfrage. Für weitere Infos über die Mindestmengen und Lieferzeiten wenden Sie sich bitte an unserer Verkaufsabteilung.

NOVA

gres tutta massa UGL









full-body porcelain
grès cérame en pleine masse
vollgemischtes durchgefärbtes feisteinzeug

spessore 10mm

thickness
épaisseur
stärke

caratteristiche tecniche* technical characteristics caractéristiques techniques technische eigenschaften	metodo di prova test method methode d'essai prüfmethode	fondi plain tile fond unifliese
 assorbimento d'acqua (E) water absorption (E) absorption d'eau (E) wasserabsorption (E)	iso 10545-3	≤ 0,04%
 resistenza al gelo frost resistance résistance au gel frostbeständigkeit	iso 10545-12	resistente résistant beständig
 resistenza alla flessione bending strength résistance à la flexion beigefestigkeit	iso 10545-4	≥ 50 N/mm ²
 sforzo di rottura (S) breaking strength (S) chargement de rupture (S) bruchlast (S)	iso 10545-4	≥ 2500 N
 resistenza all'abrasione profonda résistance to deep abrasion résistance à l'abrasion profonde widerstand gegen tiefenabrier	iso 10545-6	≤ 145 mm ³
 dilatazione termica lineare thermal expansion dilatation thermique linéaire thermische dilatation	iso 10545-8	$\alpha \leq 7 \times 10^{-6} \text{ } ^\circ\text{C}^{-1}$
 resistenza agli sbalzi termici thermal shock resistance résistance aux chocs thermiques temperatur wechselbeständigkeit	iso 10545-9	resistente résistant beständig
 resistenza attacco chimico chemical resistance résistance chimique chemischee beständigkeit	iso 10545-13	uha, ula resistente résistant beständig
 resistenza alle macchie stain resistance résistance aux taches fleckenbeständigkeit	iso 10545-14	5 resistente résistant beständig
 resistenza allo scivolamento slip resistance résistance au glissement rutschfestigkeit	din 51130	R10 (nat.) R11 (grip)
 resistenza allo scivolamento slip resistance résistance au glissement rutschfestigkeit	din 51097	B (A+B) (nat.) C (A+B+C) (grip)
 coefficiente di attrito dinamico dynamic friction coefficient coefficient de friction dynamique dynamischer reibungskoeffizient	B.C.R. tortus	$\mu > 0,40$
 dynamic coefficient of friction (DCOF)	ANSI A 137.1:2012 (BOT 3000)	DCOF \geq 0.42
 wet pendulum test AUS	AS 4586:2013	class P4 (W) (grip)
 pendulum test UK	BS 7976:2002	slider 96 wet: 36+ (grip) slider 55 wet: 36+ (grip)
 stonalizzazione shading dentuançage spieifarbig		V2

*ISO 13006-G Bla UGL – EN 14411-G Bla UGL – ANSI A 137.1 (Un glazed Porcelain Tiles - Class P1)

impieghi uses emploi anwendungsbereiche	
 alberghi hotels hotels hotels	 locali pubblici public spaces lieux publics öffentliche bereiche
 abitazioni housing maisons wohnbereiche	 aeroporti airports aéroports flughafen
 bar - ristoranti bar - restaurants bar - restaurants cafés - restaurants, gasthäuser	 centri commerciali malls centre commerciaux einkaufszentren
 negozi shops magasins geschäfte	 stazioni train stations gares bahnhöfe

imballaggi packing emballage verpackungen

articolo	scatola			europallet				
	pz.	mq	kg	scat.	mq	kg		
fondo	60x120	24"x48"	2	1,44	35,5	15	21,6	532,5
fondo	30x120	12"x48"	3	1,08	25,5	32	34,6	816,0
fondo	60x60	24"x24"	4	1,44	32,0	32	46,1	1024,0
fondo	30x60	12"x24"	8	1,44	35,5	32	46,1	1136,0
mosaico gravity	30x60	12"x24"	4	0,72	15,0	40	28,8	600,0
mosaico 3d	28x28	11"x11"	6	0,47	12,0	60	28,2	720,0
mosaico andromeda	20x30	8"x12"	6	0,36	9,0	80	28,2	720,0
bacchetta metal	1,2x60	1/2"x24"	6	0,04	0,3	250	10,8	75,0
gradino plus nat. rett.	35x120	13 3/4"x48"	2	0,84	23,2	24	20,2	556,8
gradino plus grip rett.	35x60	13 3/4"x24"	4	0,84	21,2	16	13,4	339,2
ang. gradino plus nat. rett.	35x120	13 3/4"x48"	1	0,42	12,4	24	10,1	297,6
ang. gradino plus grip rett.	35x35	13 3/4"x13 3/4"	4	0,49	13,4	30	14,7	402,0
battiscopa nat. rett.	10x60	4"x24"	12	7,2 m.l.	16,0	60	432,0 m.l.	960,0
raccordo jolly	1,3x30	1/2"x12"	16	-	1,3	-	-	-
beak jolly	1,3x2	1/2"x3/4"	4	-	0,1	-	-	-

Le rappresentazioni fotografiche e descrittive dei prodotti di Lea Ceramiche riportate sui depliant, sui cataloghi e sugli altri materiali pubblicitari dell'azienda, sono puramente illustrative dello specifico prodotto rappresentato. Si precisa infatti che, successivamente alla pubblicazione dei materiali pubblicitari dell'azienda, il prodotto potrebbe subire leggere modifiche nel relativo processo produttivo, al fine di renderlo tecnologicamente migliore. Tali aggiustamenti tecnologici potrebbero determinare lievi differenze, anche estetiche e/o cromatiche, nel prodotto medesimo, con la conseguenza che lo stesso potrebbe risultare diverso da come rappresentato e/o illustrato e/o descritto nel materiale pubblicitario di Lea Ceramiche. Tali differenze non potranno essere in alcun modo considerate dall'acquirente un vizio e/o difetto del materiale ceramico stesso, bensì una caratteristica dello specifico prodotto. Tutti i materiali ceramici che imitano pietre naturali presentano differenze di colore e sfumature che non potranno in nessun modo essere considerate quale difetto del prodotto, ma bensì una qualità caratteristica di tali tipi di produzione.

The photographs and descriptions of Lea Ceramiche products given in the brochures, catalogues and other corporate advertising materials aim merely to represent the specific products. After the publication of the corporate advertising materials, the products may be slightly modified as a result of technological improvements. Such technological modifications may lead to slight differences in appearance and/or colour of the products, which may therefore differ from the representations, illustrations or descriptions given in the Lea Ceramiche advertising materials. Such differences shall in no way be deemed to be faults and/or defects in the ceramic materials, but rather intrinsic features of the specific products. All ceramic materials that imitate natural stone differ in color and nuances, and this cannot in any way be considered as a product defect, but rather a characteristic of these types of products.



iso 14001



iso 9001



emas

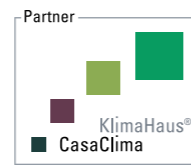

casaclima ***



leed*

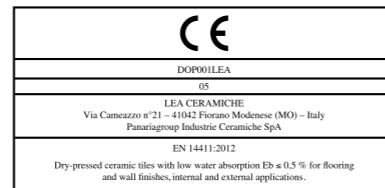

marchio CE



leed**

* LEED
Lea Ceramiche, tramite la holding Panariagroup Industrie Ceramiche S.p.A., è socio ordinario del Green Building Council e del GBC Italia. Through Panariagroup Industrie Ceramiche S.p.A., Lea Ceramiche is an ordinary member of the Green Building Council and the GBC Italia. Par le biais de Panariagroup Industrie Ceramiche S.p.A., Lea Ceramiche est membre ordinaire du Green Building Council et du GBC Italia. Lea Ceramiche, durch die Holding Panariagroup Industrie Ceramiche S.p.A., ist ordentliches Mitglied von dem Green Building Council und dem GBC Italien. Lea Ceramiche, a través del holding Panariagroup Industrie Ceramiche S.p.A., es miembro afiliado del Consejo Construcción Verde y del Consejo Construcción Verde de Italia.

** LEED
Il contenuto di materiale riciclato "pre-consumo" della serie Nova è del 40%, come certificato da ente esterno qualificato (certificato disponibile sul sito www.ceramichelea.com). Nova is produced with 40% of pre-consumer materials, as certified by a qualified external company (certificate available on the website www.ceramichelea.com).

*** CASACLIMA
Lea Ceramiche, tramite la holding Panariagroup Industrie Ceramiche S.p.A., ha ottenuto la certificazione Partner Casaclima. Through Panariagroup Industrie Ceramiche S.p.A., Lea Ceramiche has obtained the Partner Casaclima certification. Par le biais de Panariagroup Industrie Ceramiche S.p.A., Lea Ceramiche a obtenu la certification Partner Casaclima. Lea Ceramiche, durch die Holding Panariagroup Industrie Ceramiche S.p.A., hat die Bescheinigung als Partner Casaclima bekommen. Lea Ceramiche, a través del holding Panariagroup Industrie Ceramiche S.p.A., ha obtenido la certificación Partner Casaclima.



ADIMEMBER



**LEA CERAMICHE HA SCELTO MICROBAN®,
IL LEADER MONDIALE NELLA PROTEZIONE ANTIBATTERICA**
*LEA CERAMICHE CHOOSES MICROBAN®,
THE GLOBAL LEADER IN ANTIMICROBIAL TECHNOLOGY*

- **ATTIVA 24 ORE SU 24**
ACTIVE 24/7
- **EFFICACE CONTRO MACCHIE E ODORI CHE CAUSANO BATTERI**
EFFECTIVE AGAINST STAIN AND ODOR CAUSING BACTERIA
- **MOLTEPLICI APPLICAZIONI ED UTILIZZI**
MULTIPLE APPLICATIONS
- **TRATTAMENTO PERMANENTE**
PERMANENT PROTECTION
- **INTEGRATA NELLA PIASTRELLA**
INTEGRATED IN THE TILE
- **EFFICACE SU OGNI SUPERFICIE**
EFFICIENT ON ANY SURFACE

NOVA

VARIAZIONI
SUL TEMA
VARIATIONS
ON A THEME



LEA

CERAMICHE

LEA CERAMICHE
Via Cameazzo, 21
41042 Fiorano Modenese
Modena Italy

Tel +39 0536 837811
Fax +39 0536 830326
info@ceramichelea.it
www.ceramichelea.com

Panariagroup Industrie Ceramiche
S.p.A.

SHOWROOM LEA CERAMICHE
Via Durini, 3
20122 Milano

Tel +39 02 76011406
showroom_milano@ceramichelea.it

LEA NORTH AMERICA, LLC
800 Clanton Road, Suite N
Charlotte, NC 28217

Tel +1 704 522 6300
Fax +1 704 522 6080
info@leausa.us
www.leausa.us